

Milwaukee[®]

Nothing but **HEAVY DUTY.**[™]



2025

HAND TOOLS CATALOGUE



Milwaukee®

CONTENTS

CUTTING		HAMMERS	33-36
Bolt Cutters	31-32	HOOK & PICK SET	79
Cable Cutter	31	MEASURING AND MARKING	
Knives and Blades	22-26	Chalk Reel	18
Metal Snips	29	Framing Square	19
Sawing	27-28	INKZALL™ Markers	20-21
Scissors	28	Levels	10-17
Tubing Cutters	29-31	Long Tapes	9-10
		Rafter Square	19
DEMOLITION		Short Tapes	4-8
Nail Puller	32		
Pry Bars	79		
Trim puller	33		
Wrecking bar	33		
FISH TAPE	44		
GRIPPING AND FASTENING			
HOLLOWCORE™ Magnetic Nut Drivers	43		
Pliers	46-51		
Ratchets	63-74		
Screwdrivers	39-42, 45		
Sockets	63-76		
Spanners	57-62		
TORQUE LOCK™ Clamps	52-53		
TORQUE LOCK™ Pliers	51		
Wrenches	53-56		

Tape measures STUD™ II



- EXO 360™ blade technology delivers long lasting, rip and wear resistance.
- Strong magnet at start of the tape allows easy hooking onto flat surfaces and round pipe.
- Up to 4 m standout - higher standout for higher efficiency and higher reach.
- Anti-tear coating - reinforces the first 15 cm of the blade.
- 2 sided blade printing - increases the readability.
- Patented finger stop - protects fingers from blade retraction.
- ABS housing with impact resistant overmold for more comfort and jobsite durability.
- Wire form belt clip - reduces pocket tearing.
- Tool lanyard hole - Ready for quick and easy tethering.
- Class II accuracy.

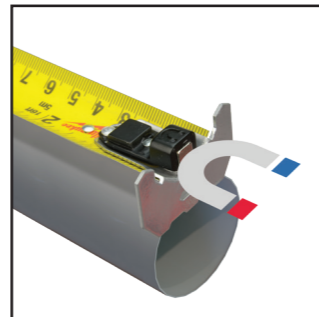

Strong magnet



4M STANDOUT

Description	Length (m)	Blade width (mm)	Pack quantity	Min. order quantity	Article Number	EAN Code
STUD Gen2 5 m	5	33	1	6	4932471626	4058546295257
STUD Gen2 8 m	8	33	1	6	4932471627	4058546295264
STUD Gen2 5 m 16 ft	5 / 16'	33	1	6	4932471628	4058546295271
STUD Gen2 8 m 26 ft	8 / 26'	33	1	6	4932471629	4058546295288



Premium wide blade tape measures

- Up to 4 m standout - higher standout for higher efficiency and higher reach.
- Anti-tear coating - reinforces the first 15 cm of the blade.
- 2 sided blade printing - increases the readability.
- Impact resistant 5 points - reinforces the frame and makes it more durable.
- Patented finger stop - protects fingers from blade retraction.
- Wire form belt clip - reduces pocket tearing.
- Nylon bond blade protection - reduces tape tear.
- Tool lanyard hole - Ready for quick and easy tethering.



4M STANDOUT



Description	Length (m)	Blade width (mm)	Pack quantity	Min. order quantity	Article Number	EAN Code
Premium wide blade 5 m	5	33	1	6	4932471815	4058546297145
Premium wide blade 8 m	8	33	1	6	4932471816	4058546297152
Premium wide blade 5 m 16 ft	5 / 16'	33	1	6	4932471817	4058546297169
Premium wide blade 8 m 26 ft	8 / 26'	33	1	6	4932471818	4058546297176

Magnetic tape measures GEN III



- Strong magnet at start of the tape allows easy hooking onto flat surfaces and round pipe.
- Compact and ergonomic design.
- Improved standout up to 3.4 m.
- Nylon non-reflective bond blade protection, up to 10x more resistant to jobsite damage.
- 27 mm blade with double sided printing on tape for easier readability.
- Patented finger stop: stable when stands alone.
- 5-point reinforced frame for jobsite durability.
- Class II accuracy.
- Architect scale provides easy calculating of scaled drawings.



Description	Length (m)	Blade width (mm)	Pack quantity	Min. order quantity	Article Number	EAN Code
Magnetic Tape Measure 5 m	5	27	1	6	4932464599	4058546225445
Magnetic Tape Measure 8 m	8	27	1	6	4932464600	4058546225452
Magnetic Tape Measure 10 m	10	27	1	6	4932464601	4058546225469
Magnetic Tape Measure 5 m - 16 ft	5 / 16'	27	1	6	4932464602	4058546225476
Magnetic Tape Measure 8 m - 26 ft	8 / 26'	27	1	6	4932464603	4058546225483



Tape measure Autolock

- Autolock brake: tape automatically locks in place as blade is pulled out.
- Nylon coated blade protection against debris, dirt and water.
- 5 Point reinforced housing for outstanding tape lifetime.
- ABS housing with impact resistant overmold for more comfort and jobsite durability.
- Compact design and comfortable size.
- Heavy Duty belt clip.
- Class II accuracy.
- Bulk packed, order in multiples of 6pcs.



Description	Length (m)	Blade width (mm)	Pack quantity	Min. order quantity	Article Number	EAN Code
Tape measure Autolock 5 m	5	25	1	6	4932464663	4058546226084
Tape measure Autolock 8 m	8	25	1	6	4932464664	4058546226091
Tape measure Autolock 5 m - 16 ft	5	25	1	6	4932464665	4058546226107
Tape measure Autolock 8 m - 26 ft	8	25	1	6	4932464666	4058546226114

LED Magnetic Tape Measure 7.5 m

- 100 Lumens LED light, to illuminate up to 3 m work area.
- Conveniently charge MILWAUKEE® Rechargeable internal battery with included micro-USB cable.
- Charging indicator red/ orange/ green to be able to read out the charging status of the battery.
- 2.5 hour of battery run time.
- 30 mm blade with double sided printing on tape for easier readability and architect scale provides easy calculating of scaled drawings.
- Improved standout up to 4.6 m.
- Finger stop for comfortable hold and finger protection when the blades retracts.
- Strong magnet at start of the tape allows easy hooking onto flat surfaces and round pipe.
- Overmold gripping area for extra comfort and durability.
- Anti-tear coating - reinforces the first 15 cm of the blade.
- Nylon non-reflective bond blade protection, up to 10x more resistant to jobsite damage.
- Class II accuracy.



Description	Length (m)	Blade width (mm)	Pack quantity	Min. order quantity	Article Number	EAN Code
LED Magnetic Tape Measure 7.5 m	7.5	30	1	1	4932492469	4058546418366

Tape measures pro compact

- Improved ergonomics and comfortable size.
- Jobsite durability.
- 5-point reinforced housing.
- 2G nylon coated blade protection.
- Improved tape tear and flexibility.
- Withstands 3 m drop test.
- Non magnetic.
- Heavier font on measurements for better readability.
- Smaller compact hook design.
- Back rest for easy vertical measuring.
- Improved belt clip: more pocket friendly.



Description	Length (m)	Blade width (mm)	Pack quantity	Min. order quantity	Article Number	EAN Code
Tape measure pro compact C5/25	5	25	1	6	4932459593	4058546027650
Tape measure pro compact C8/25	8	25	1	6	4932459594	4058546027667
Tape measure pro compact C5-16/25	5 / 16'	25	1	24	4932459595	4058546027674
Tape measure pro compact C8-26/25	8 / 26'	25	1	12	4932459596	4058546027681

Tape measure with LED Light

- 19 LUX LED Light: helps finding measured spot.
- Nylon lacquer blade protection against debris, dirt and water.
- 4 Point reinforced housing for outstanding tape lifetime.
- ABS housing with impact resistant overmold for more comfort and jobsite durability.
- Compact design and comfortable size.
- Magnet on the rear side of the tape for attaching to metal tool boxes and other metal surfaces.
- 2x CR2016 batteries are included in the delivery scope.
- Class II accuracy.
- Bulk packed, order in multiples of 12 pcs.



Description	Length (m)	Blade width (mm)	Pack quantity	Min. order quantity	Article Number	EAN Code
3 m/ 10 ft tape measure with LED	3	12	1	12	48226602	045242529285

Tape measures slimline

- Very compact and improved ergonomic design.
- Nylon coated blade protection against debris, dirt and water.
- ABS housing with softgrip rubber gripping area for extra comfort and jobsite durability.
- 4-point reinforced frame.
- Flat base for horizontal stability and back rest for easy vertical measuring.
- Belt clip.
- Class II accuracy.
- Orders are only possible in master cartons with 24, 12 or 6 tapes depending on sku.



Description	Length (m)	Blade width (mm)	Pack quantity	Min. order quantity	Article Number	EAN Code
S3 / 16	3	16	1	12	48227703	045242512898
S5 / 25	5	25	1	6	48227706	045242512911
S8 / 25	8	25	1	6	48227708	045242512928
S5-16 / 25	5/16'	25	1	24	48227717	045242512935
S8-26 / 25	8/26'	25	1	24	48227726	045242512942

Long open tapes

- Steel blade design with nylon clad (extra thick nylon coating) for increased durability.
- Best in class stretch performance: up to 50% less stretch vs. fibreglass tapes.
- Ultra durable design: reinforced metal handle and drop durability.
- 3:1 clutched planetary gearing for 10x longer gear durability and smooth rewind.
- GRIME GUARD: debris wiper keeps blade clean and clear of abrasive material.
- Class II accuracy.
- 2 sided scale printing. Metric measurements shown on the top side and imperial (inches and feet) on the underside of the blade.



Description	Length (m)	Blade width (mm)	Pack quantity	Min. order quantity	Article Number	EAN Code
① Long open tape combi 30 m/ 100 ft	30	13	1	1	48225203	045242486069
② Long open tape combi 100 m/ 330 ft	100	9.5	1	1	48225211	045242486076

Tape measure - 2 m / 6 ft



- 5-point reinforced frame for job site durability.
- Heavy duty blade with 13 mm blade width.
- Double sided nylon bond blade protection for extreme tape durability against dust, dirt, debris and water.
- Compact design and overmould gripping area for extra comfort and durability.
- Bulk packed, order in multiples of 12 pcs.

Description	Length (m)	Pack quantity	Min. order quantity	Article Number	EAN Code
2 m/ 6 ft metric & imperial tape measure	2	1	12	48225502	045242468034

Fibreglass long tapes

- Fibreglass blade ensures a low tape weight.
- 3:1 clutched planetary gearing for 10x longer gear durability and smooth rewind.
- GRIME GUARD: debris wiper keeps blade clean and clear of abrasive material.
- 2 sided scale printing. Metric measurements shown on the top side and imperial (inches and feet) on the underside of the blade.



Description	Length (m)	Blade width (mm)	Pack quantity	Min. order quantity	Article Number	EAN Code
① Fibreglass long tape combi 30 m/ 100 ft	30	13	1	1	48225330	045242527731
② Fibreglass long tape combi 60 m/ 200 ft	60	13	1	1	48225360	045242527748

Long closed tapes

- Single sided 30 m metric tape with 9.5 mm blade width.
- GRIME GUARD: debris wiper keeps blade clean and clear of abrasive material.
- Ultra durable design: reinforced metal frame housing, reinforced handle and steel blade with nylon coating.
- 3:1 clutched planetary gearing for 10x longer gear durability and smooth rewind.
- Class II accuracy.



Description	Length (m)	Blade width (mm)	Pack quantity	Min. order quantity	Article Number	EAN Code
Long closed tape 30 m	30	9.5	1	1	48225103	045242486106

Digital Angle Gauge

NEW

- Real-time measurements for quicker readings and to save time by reducing unnecessary screen delays.
- Easy digital navigation with an auto-rotating LCD screen.
- Angle assist arrows that point to the nearest 90-degree for quick angle finding.
- Auto-shutoff feature saves battery life.
- Hold mode to fix the current measured value in the display.
- Magnet to securely attach to metal surfaces for increased productivity.
- Compact design for lightweight and handy use.
- Accuracy $\pm 0.1^\circ$ at 0° and 90° ; $\pm 0.2^\circ$ between 1° and 89° .
- Includes a soft carrying case for easy and convenient storage and 2 x AAA batteries.



Description	Min. order quantity	Pack quantity	Article Number	EAN Code
Digital Angle Gauge	1	1	4932493656	4058546485276



Digital levels



- PINPOINT measurement technology provides layers of information to include numeric, graphic, color and audio for advanced readability.
- PIN Mode allows user to lock in any target within 360° for replicating measurements or finding a specific measurement.
- Powered by REDLITHIUM™ USB rechargeable battery.
- Up to 2x greater accuracy.
- Simple menu selection for quick set-up: Mode, Sensitivity, Tolerance, Power and Language.
- Tolerance can be adjusted for precision, standard and rough-in work.
- IP65 rated protects against job site debris.
- Accurate to: 0° , $90^\circ/0.03^\circ$ and $1^\circ-89^\circ/0.10^\circ$.
- Durable all-metal hang hole for easy storage.

Description	Length (cm)	Handles	Pack quantity	Min. order quantity	Article Number	EAN Code
Digital level 60 cm	60	0	1	1	4933471978	4058546298777
Digital level 120 cm	120	2	1	1	4933471979	4058546298784

Expandable level



- Cover any length from 200 cm - 366 cm with laser etched measurements.
- SHARPSITE™ vial technology improves the readability of the vial.
- Reinforced internal components protect the level from damage or wear.
- Precision milled measuring surface provides accuracy in all working positions.
- Accurate to 0.029° (0.0005° / in, 0.5 mm/ m) in normal and reverse position.
- High contrast vial system is easy to clean and optimises visibility.
- Full grip frame for improved ergonomics in transport & application.
- Secure tool-removable stand offs.

Description	Length (cm)	Handles	Pack quantity	Min. order quantity	Article Number	EAN Code
Expandable 200 cm - 366 cm	200 - 366	2	1	1	4932471355	4058546289836



REDSTICK™ BACKBONE™ box levels



Strong and durable frame, reinforced BACKBONE™



SHARPSITE™ vial technology improves the readability of the vial

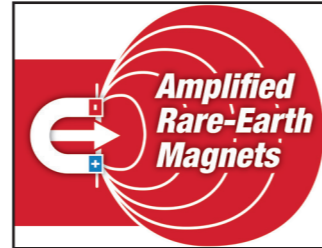

Amplified rare earth magnets for maximum holding power (only magnetic levels)



- Reinforced BACKBONE™. Strong and durable frame. Reinforced vial retention.
- SHARPSITE™ vial technology improves the readability of the vial.
- Wide, durable handles for comfort and portability.
- Precision milled measuring surface provides accuracy in all working positions.
- High contrast vial system is easy to clean and optimises visibility.
- Shock absorbing end caps protect the frame.
- Overmolded, non-slip grips stick to the wall and prevent sliding.
- Durable, all-metal hang hole for storage.
- Accurate to 0.029° (0.0005 ʹ in, 0.5 mm/ m) in normal and reverse position.
- Amplified rare earth magnets for maximum holding power (only magnetic levels).



Description	Length (cm)	Handles	Pack quantity	Min. order quantity	Article Number	EAN Code
40 cm magnetic	40	0	1	1	4932459061	4002395280322
60 cm magnetic	60	0	1	1	4932459063	4002395280346
80 cm magnetic	80	1	1	1	4932459065	4002395280360
100 cm magnetic	100	0	1	1	4932459067	4002395280384
120 cm magnetic	120	2	1	1	4932459069	4002395281008
180 cm magnetic	180	2	1	1	4932459071	4002395281046
200 cm magnetic	200	2	1	1	4932459073	4002395281060
240 cm magnetic	240	2	1	1	4932459075	4002395281084
40 cm non-magnetic	40	0	1	1	4932459060	4002395280315
60 cm non-magnetic	60	0	1	1	4932459062	4002395280339
80 cm non-magnetic	80	1	1	1	4932459064	4002395280353
100 cm non-magnetic	100	0	1	1	4932459066	4002395280377
120 cm non-magnetic	120	2	1	1	4932459068	4002395280391
180 cm non-magnetic	180	2	1	1	4932459070	4002395281015
200 cm non-magnetic	200	2	1	1	4932459072	4002395281053
240 cm non-magnetic	240	2	1	1	4932459074	4002395281077
End-caps for REDSTICK™ BACKBONE™ levels			2	1	4932459680	4058546028527

REDSTICK™ compact box levels



- SHARPSITE™ vial technology improves the readability of the vial.
- Compact and durable frame.
- Bottom milled measuring surface provides maximum accuracy.
- High contrast vial system is easy to clean and optimises visibility.
- Amplified rare earth magnets for maximum holding power (only magnetic levels).
- Accurate to 0.029° (0.0005 ʹ in, 0.5 mm/ m) in standard position.
- Shock absorbing rubber end caps.



Description	Length (cm)	Handles	Pack quantity	Min. order quantity	Article Number	EAN Code
40 cm magnetic	40	0	1	1	4932459079	4002395281725
60 cm magnetic	60	0	1	1	4932459081	4002395281749
80 cm magnetic	80	0	1	1	4932459083	4002395281763
100 cm magnetic	100	0	1	1	4932459085	4002395281787
120 cm magnetic	120	0	1	1	4932459087	4002395282401
180 cm magnetic	180	0	1	1	4932459089	4002395282425
40 cm non-magnetic	40	0	1	1	4932459078	4002395281718
60 cm non-magnetic	60	0	1	1	4932459080	4002395281732
80 cm non-magnetic	80	0	1	1	4932459082	4002395281756
100 cm non-magnetic	100	0	1	1	4932459084	4002395281770
120 cm non-magnetic	120	0	1	1	4932459086	4002395281794
180 cm non-magnetic	180	0	1	1	4932459088	4002395282418
End-caps for REDSTICK™ compact levels			2	1	4932459681	4058546028534

Slim box levels



- 2 solid acrylic vials. Shockproof and UV resistant.
- Precision milled measuring surface up to 120 cm provides maximum accuracy.
- Shock absorbing end caps.
- Durable hang hole for storage.
- VPA third party certificate on accuracy.
- Accurate to 0.029° (0.0005 ʹ in, 0.5 mm/ m) in standard position.



Description	Length (cm)	Pack quantity	Min. order quantity	Article Number	EAN Code
40 cm magnetic	40	1	1	4932464854	405854627999
60 cm magnetic	60	1	1	4932464855	4058546228002
100 cm magnetic	100	1	1	4932464856	4058546228019
180 cm magnetic	180	1	1	4932464857	4058546228026
① 20 cm non-magnetic	20	1	10	4932472091	4058546324872
40 cm non-magnetic	40	1	1	4932459090	4002395282432
60 cm non-magnetic	60	1	1	4932459091	4002395282449
80 cm non-magnetic	80	1	1	4932459092	4002395282456
100 cm non-magnetic	100	1	1	4932459093	4002395282463
120 cm non-magnetic	120	1	1	4932459094	4002395282470
180 cm non-magnetic	180	1	1	4932459095	4002395282487
200 cm non-magnetic	200	1	1	4932459090	4058546027629



I-beam levels



- Lightweight reinforced aluminium frame.
- Magnetic edge allows hands free use when working with metal.
- Accurate to 0.029° (0.0005 7/ in, 0.5 mm/ m) in normal and reverse position.
- Pitch vial for easy reading of 1 and 2 degree pitch.
- High contrast vial surrounds for maximised visibility.
- Shock absorbing end caps.



Description	Length (cm)	Handles	Pack quantity	Min. order quantity	Article Number	EAN Code
I-Beam level magnetic - 60 cm	60	1	1	1	4932478565	4058546347581
I-Beam level magnetic - 120 cm	120	2	1	1	4932478566	4058546347598
I-Beam level magnetic - 200 cm	200	2	1	1	4932478567	4058546347604

REDCAST die-cast levels



- 2 solid acrylic vials. Shockproof and UV resistant.
- 2 heavy duty cast aluminium "anvil" strike pads for trowel blows during tile work.
- Drill bit diameter gauge in the level's profile from 5 to 12 mm.
- Precision milled measuring surface provides maximum accuracy.
- Durable hang hole for storage.
- VPA third party certificate on accuracy.
- Accurate to 0.029° (0.0005 7/ in, 0.5 mm/ m).



Description	Length (cm)	Pack quantity	Min. order quantity	Article Number	EAN Code
REDCAST die-cast level 60 cm	60	1	1	4932459098	4002395283118
REDCAST die-cast level 80 cm	80	1	1	4932459099	4002395283125

Block torpedo level



- SHARPSITE™ vial technology improves the readability of the vial.
- Locking 360° adjustable vial. Identify and repeat any angle needed on the jobsite. Lock vial in place to keep accuracy in and out of pocket/ pouch.
- Amplified rare earth magnets for maximum holding power.
- Reinforced plumb vials. Solid, acrylic block vials offer maximum durability.
- Die cast aluminium body withstands the conditions of the jobsite.
- Precision milled measuring surface provides maximum accuracy.
- Lanyard hole for use with all most prevention programs.
- Accurate to 0.029° (0.0005 7/ in, 0.5 mm/ m).



Description	Length (cm)	Pack quantity	Min. order quantity	Article Number	EAN Code
Block torpedo level	25	1	1	4932459096	4002395282494

Billet torpedo level



- Amplified rare earth magnets for maximum holding power.
- Maximised viewing area. Easily read slope in 1/8" or 1/4" per foot in either direction.
- Reinforced acrylic vials offer maximum durability.
- Weld clearance. Easily level over weld joints in pipes and other materials.
- Optimised V-groove design for stability on non-ferrous pipes.
- Laser etched ruled edge for quick measurements on material.
- Slim, tapered design for easy sliding in and out of pockets and pouches.



Description	Length (cm)	Pack quantity	Min. order quantity	Article Number	EAN Code
Billet torpedo level	17	1	1	4932459097	4002395283101

LED Torpedo Level

NEW

- 2 x LED-integrated Hi-vis spirit vials ensure perfect readability in poor lighting conditions.
- High contrast vial surrounds increase vial visibility.
- Amplified rare earth magnets for maximum holding power.
- Optimized V-groove working edge for stability on pipes and conduits.
- Durable aluminum frame for the conditions on the job site.
- Slim, tapered design for easy sliding in and out of pockets and pouches.
- Accurate to 0.029° (0.0005 ʹ/ in, 0.5 mm/ m).



Description	Length (cm)	LED	Magnetic	Pack quantity	Min. order quantity	Article Number	EAN Code
LED Torpedo Level	23	Yes	3 - Rare earth magnets	1	1	4932498742	4058546526115

Base Torpedo Level

NEW

- High contrast vial surrounds increase vial visibility.
- 3 x Hi-vis fluid vials provide improved readability and accuracy.
- Amplified rare earth magnets for maximum holding power.
- Optimized V-groove working edge for stability on pipes and conduits.
- Durable aluminum frame for the conditions on the job site.
- Slim, tapered design for easy sliding in and out of pockets and pouches.
- Accurate to 0.029° (0.0005 ʹ/ in, 0.5 mm/ m).



Description	Length (cm)	Magnetic	Pack quantity	Min. order quantity	Article Number	EAN Code
Base Torpedo Level	25	3 - Rare earth magnets	1	1	4932498716	4058546525859



Pocket level



- 360° adjustable vial for reading angles.
- Locking mechanism for repetitive use in and out of pocket/ pouch.
- Amplified rare-earth magnets for maximum holding power.
- V-groove for leveling on pipes.
- Milled edge to ensure accuracy.
- Compact size for jobsite functionality.



Description	Length (cm)	Pack quantity	Min. order quantity	Article Number	EAN Code
Pocket level	7.8	1	6	4932459597	4058546027698

Compact torpedo



- SHARPSITE™ pitch vial for easy reading of 1 and 2 degree pitch.
- Sub compact design for working in tight spaces.
- Optimized V-groove design for stability of rounded surfaces.
- Weld clearance to level over weld lines in pipe and other material.
- Amplified rare earth magnets for maximum holding power.
- Accurate to 0.029° (0.0005 ʹ/ in, 0.5 mm/ m).



Description	Length (cm)	Pack quantity	Min. order quantity	Article Number	EAN Code
Compact torpedo	7.6	1	1	4932472122	4058546325183

Minibox level



- Lightweight aluminium box profile fits easily into your tool belt or pocket.
- Solid acrylic vial. Shockproof and UV resistant vials.
- Shockproof end caps.
- Accurate to 0.029° (0.0005 ʹ/ in, 0.5 mm/ m) in standard position.
- VPA third party certificate on accuracy.



Description	Length (cm)	Pack quantity	Min. order quantity	Article Number	EAN Code
Minibox level	10	1	10	4932459100	4002395283446



Chalk reel

- Extra bold lines - 2 mm thick line for maximum visibility.
- Planetray gear system for increased durability.
- 4/1 gear ratio for fast line retraction.
- Large chalk capacity.
- Easy refills due to the extra large quick turn opening.
- Easy line securing due to the line lock.



Description	Pack quantity	Min. order quantity	Article Number	EAN Code
① 30 m large capacity chalk reel	1	1	4932471634	4058546295332
② 45 m large capacity chalk reel	1	1	4932471635	4058546295349
③ 30 m replacement line chalk reel	1	1	4932471636	4058546295356
④ 45 m replacement line chalk reel	1	1	4932471637	4058546295363

Fine Line Chalk Reel

- 6:1 retraction ratio for fast line retraction to get the job done faster.
- Planetary gear system for increased durability.
- Flush handle storage prevents handle movement when not in use.
- Line width of 0.9mm for precise work and 30m line length.
- All metal body to protect the tool from the toughest jobsite conditions.
- Low spillage line for minimal chalk spill which reduces the clean up time.



Description	Colour	Min. order quantity	Pack quantity	Article Number	EAN Code
① Fine Line Chalk Reel & Blue Chalk Refill	Blue	1	2	4932493814	4058546509743
② Fine Line Chalk Reel & Red Chalk Refill	Red	1	2	4932498390	4058546522599

Bold Line Chalk Reel

- 6:1 retraction ratio for fast line retraction to get the job done faster.
- Planetary gear system for increased durability.
- Flush handle storage prevents handle movement when not in use.
- Line width of 1.5mm for clear visibility and 30m line length.
- Rubber overmold on the housing for improved grip and to protect from toughest jobsite conditions.



Description	Colour	Min. order quantity	Pack quantity	Article Number	EAN Code
① Bold Line Chalk Reel & Blue Chalk Refill	Blue	1	2	4932493815	4058546509750
② Bold Line Chalk Reel & Red Chalk Refill	Red	1	2	4932498391	4058546522605

Framing Square

NEW

- Reinforced frame.
- Laser etched markings provide superior visibility.
- Precision scribe notches for easy marking.
- Common conversion table.
- Markings to assist in angle finding.



Description	Length (cm)	length (Inch)	Pack quantity	Min. order quantity	Article Number	EAN Code
Framing Square Metric	20 x 30	-	1	1	4932498718	4058546525873
Framing Square Imperial	40 x 60	-	1	1	4932472126	4058546325220
Framing Square Imperial	-	16 x 24	1	1	4932472125	4058546325213

Rafter Square

- Precision scribe notches for easy marking.
- High visibility laser etched markings.
- Pipe prop to assist in cutting pipe materials.
- Increased heel width for improved grip.



Description	Length (cm)	length (Inch)	Pack quantity	Min. order quantity	Article Number	EAN Code
Rafter Square Metric	18	-	1	1	4932472124	4058546325206
Rafter Square Imperial	-	7	1	1	4932472123	4058546325190



INKZALL™ markers

- Stays sharp, doesn't mushroom or push back under pressure.
- Acrylic nib ideal for rough surfaces such as OSB and concrete.
- Marker continues to write after 72+ hours of cap off time.
- For use on concrete, wood, metal, plywood, OSB, plastic.
- Can be used on wet, oily, dusty, rusty, with debris surfaces.
- Quick dry time – reduced smearing markings on PVC, metal surfaces.
- Thin body for use in restricted areas.
- Helmet clip – can be clipped to the construction site cap, trousers, overalls.
- Easy open cap for one hand operation.
- Anti-Roll design - won't roll off surfaces.

Description	Colour	Tip	Pack quantity	Min. order quantity	Article Number	EAN Code
① INKZALL™ marker*	Black	1 mm	1	36	48223100	045242319473
② INKZALL™ marker*	Red	1 mm	1	36	48223170	045242355259
③ INKZALL™ marker*	Blue	1mm	1	36	4932492126	4058546414931
④ INKZALL™ marker	Green	1mm	1	36	4932492127	4058546414948
⑤ INKZALL™ marker with stylus	Black	1 mm	1	1	48223101	045242297436
⑥ INKZALL™ fine tip markers	Black	0.6 mm	4	1	48223154	045242479764
⑦ INKZALL™ colour markers Blue, Red, Green, Black		1 mm	4	1	48223106	045242333585
⑧ INKZALL™ chisel point marker	Black	1- 4,8 mm	1	1	48223103	045242333608

* Orders are only possible in master cartons (contains 36 x 48223100). Minum order quantity is 36 pcs (= 1 master carton). Order quantities greater than 36 pcs are to be ordered in multiples of 36 pcs (i.e. 72, 108, 144, 180...).

INKZALL™ chisel tip markers

- Marker continues to write after 72+ hours of cap off time.
- Can be used on wet, oily, dusty, rusty, with debris surfaces.
- For use on concrete, wood, metal, plywood, OSB, plastic.
- Quick dry time – reduced smearing markings on PVC, metal surfaces.
- Easier to read from a distance due to the increased chisel tip sizes.

Description	Colour	Tip	Pack quantity	Min. order quantity	Article Number	EAN Code
① INKZALL™ black chisel tip marker L (3 pc)	Black	6.2 mm	3	1	4932471554	4058546294533
② INKZALL™ black chisel tip marker L	Black	6.2 mm	1	12	4932471555	4058546294540
③ INKZALL™ red chisel tip marker L	Red	6.2 mm	1	12	4932471556	4058546294557
④ INKZALL™ blue chisel tip marker L	Blue	6.2 mm	1	12	4932471557	4058546294564
⑤ INKZALL™ black chisel tip marker XL (1 pack)	Black	14.5 mm	1	1	4932471558	4058546294571
⑥ INKZALL™ black chisel tip marker XL	Black	14.5 mm	1	12	4932471559	4058546294588
⑦ INKZALL™ red chisel tip marker XL	Red	14.5 mm	1	12	4932471560	4058546294595
⑧ INKZALL™ blue chisel tip marker XL	Blue	14.5 mm	1	12	4932471561	4058546294601



INKZALL™ liquid paint markers

- Valve action marker.
- Durable acrylic nib for the most demanding environmental conditions: surface temperature from -10° up to + 145°.
- Marks on dark surfaces where traditional markers would not be easily visible.
- Can be used on rough, dirty and greasy surfaces.
- For use on concrete, black pipe, aluminium, PVC, steel & stainless steel, rubber and tyres.
- 10 seconds dry time.
- Water and UV resistant markings.
- Permanent markers. Markings last up to 6 months.
- Metal barrel for construction site durability.
- Xylene-free paint.
- IMPORTANT: Shake the marker with the cap on. Remove the cap and carefully pump it up and down until ink flows into the nib.



Description	Colour	Pack quantity	Min. order quantity	Article Number	EAN Code
① INKZALL™ liquid paint marker	Yellow	1	12	48223721	045242363377
② INKZALL™ liquid paint marker	White	1	12	48223711	045242363360
③ INKZALL™ liquid paint marker	Black	1	12	48223731	045242363384
④ INKZALL™ liquid paint marker	Blue	1	12	4932492144	4058546415112
⑤ INKZALL™ liquid paint marker	Red	1	12	4932492143	4058546415105



INKZALL™ highlighters

- Durable tip stays sharp longer.
- No smearing, doesn't bleed through.
- Non-toxic ink, ASTM D 4236 certification.
- Ideal for architectural drawings, labels, office paper.
- Anti-roll body design for better grip on smooth surfaces.
- Construction helmet clip: the INKZALL™ highlighters can be clipped to the helmet, trousers, overalls, etc.
- Lanyard hole, e.g. to attach the INKZALL™ highlighters to the belt.

Description	Pack quantity	Min. order quantity	Article Number	EAN Code
① INKZALL™ highlighter - yellow	5	1	48223201	045242482573
② INKZALL™ highlighter - coloured	5	1	48223206	045242482580



INKZALL™ fine tip pens

- Approx. 0.6 mm tip.
- Clog resistant.
- Main applications: marking of labels for electrical wires, adding comments to architect plans.

Description	Colour	Pack quantity	Min. order quantity	Article Number	EAN Code
① INKZALL™ fine tip pens (4 pc) - black	Black	4	1	48223164	045242479818
② INKZALL™ fine tip pens (4 pc) - coloured	Black, Red, Blue	4	1	48223165	045242479825



FASTBACK™ flip utility knife

- Integrated gut hook. Allows users to make cuts without exposing the blade.
- Tool free blade change. Less down time in the field for blade changes.
- Wire stripper. Eliminates the need to look for another tool in user's bag.
- Thin body design. Tool is easily stored in user's pocket.
- Belt clip for easy storage.



Description	Pack quantity	Min. order quantity	Article Number	EAN Code
① FASTBACK™ compact flip utility knife	1	1	4932471356	4058546289843
② FASTBACK™ flip utility knife	1	6	4932471357	4058546289850
③ FASTBACK™ flip utility knife with blade storage	1	1	4932471358	4058546289867

FASTBACK™ 5 in 1 folding knife

- Stainless steel blade.
- Liner lock secures the blade in the open position.
- Partially serrated for versatility making it easier to both pierce and tear through material.
- The folding knife includes a fold-out 1/4" bit holder along with a reversible PH2 and slotted bit.
- Built-in bottle opener for added functionality.
- Durable belt clip that reduces pocket tearing.
- Lanyard hole for easy attachment to the Milwaukee safety range to allow use at heights.



Description	Pack quantity	Min. order quantity	Article Number	EAN Code
FASTBACK™ 5 in 1 folding knife	1	1	4932492454	4058546418212

FASTBACK™ 6 in 1 utility knife

- 1/4" Hex bit holder with double ended PH2 and SL5.5. Tool free blade change. Less down time in the field for blade changes.
- Wire stripper. Eliminates the need to look for another tool in user's bag.
- Belt clip for easy storage.
- Integrated bottle opener.

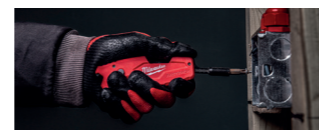

Description	Pack quantity	Min. order quantity	Article Number	EAN Code
FASTBACK™ 6 in 1 utility knife	1	1	4932478559	4058546347529

FASTBACK™ folding knife

- Resharpenable stainless steel blade.
- Piercing tip allows controlled piercing and smooth cutting.
- Liner lock secures the blade in the open position.
- Lanyard hole.
- Wire form belt clip for quick access without fraying pockets.



Description	Pack quantity	Min. order quantity	Article Number	EAN Code
① FASTBACK™ folding knife	1	1	48221990	045242296842
② FASTBACK™ Camo folding knife	1	1	4932492375	4058546417420

Compact pocket knife

- Compact size for carrying in the pocket.
- Resharpenable stainless steel blade.
- Piercing tip allows controlled piercing and smooth cutting.
- Liner lock secures the blade in the open position.
- Lanyard hole.



Description	Pack quantity	Min. order quantity	Article Number	EAN Code
① Compact pocket knife	1	1	4932478560	4058546347536
② Compact Pocket Knife Counter Display	1	10	4932492661	4058546414115

Fixed blade knife

- The fixed blade knife is designed for optimal edge retention and durability.
- 4" (101mm) stainless steel blade, optimised to stay sharper longer.
- Full metal tang provides durability for tough cut.
- Ergonomic handle offers secure and comfortable grip.
- Lanyard hole for easy tethering.
- Durable moulded sheath with belt clip for fast access.



Description	Pack quantity	Min. order quantity	Article Number	EAN Code
Fixed blade knife	1	1	4932464828	4058546227739

Hawkbill fixed blade knife

- The hawkbill fixed blade knife is ideal for stripping wire and cable.
- Stainless steel blade is optimised to stay sharper longer.
- Full metal tang provides durability for tough cuts.
- Large ergonomic handle designed for comfortable use with gloves.
- Lanyard hole for easy tethering.
- Durable molded sheath with belt clip for fast access.



Description	Pack quantity	Min. order quantity	Article Number	EAN Code
Hawkbill fixed blade knife	1	1	4932464829	4058546227746

HARDLINE™ folding knives

- Premium D2 blade steel provides better corrosion resistance. High strength and wear resistance, stays sharp longer.
- Smooth / serrated blade and piercing tip. Ideal for tearing through material and tip allows controlled piercing.
- Flip opening with bearing system: can be opened with 1 hand only.
- Opening steel frame lock secures the blade in the open position.
- Glass filled nylon handle with stainless steel.
- Liner lock secures the blade in the open position.
- Lanyard hole for easy attachment to the Milwaukee safety range to allow use at heights.
- Reversible belt clip allows right or left handed carry.



Description	Blade type	Pack quantity	Min. order quantity	Article Number	EAN Code
① HARDLINE™ Folding Knife 75mm - Smooth	Smooth	1	1	48221994	045242477043
② HARDLINE™ Folding Knife 75mm - Serrated	Serrated	1	1	48221998	045242359165
③ HARDLINE™ Folding Knife 64mm - Smooth	Smooth	1	1	4932492452	4058546418199
④ HARDLINE™ Folding Knife 89mm - Smooth	Smooth	1	1	4932492453	4058546418205

HARDLINE™ fixed blade knife

- 5" (127 mm) AUS-8 Steel blade allows the blade to hold its edge longer, reducing the user's need to sharpen.
- Full metal tang provides durability for tough cuts.
- Overmolded handle for a strong secure grip, and a lanyard hole.
- Durable multi position sheath for flexible carry option and fast access.



Description	Pack quantity	Min. order quantity	Article Number	EAN Code
HARDLINE™ fixed blade knife	1	1	4932464830	4058546227753

Fixed blade utility knife

- Ready to use fixed blade for an easier and fastest access to the knife.
- Tool-free blade change: Saves time changing blades. Thumb-screw mechanism allows to change the blade quickly and without any extra tools.
- Blade storage holds up to 5 blades conveniently inside the handle.
- Tool lanyard hole for easy tethering.
- Heavy Duty: Durable full metal body.



Description	Pack quantity	Min. order quantity	Article Number	EAN Code
Fixed blade utility knife	1	1	4932471361	4058546289898

Sliding utility knife

- Side slide mechanism to reduce the risk of exposing the blade accidentally.
- Full metal body with rubber overmold for increased durability, comfort and reduced hand slippage.
- Tool free blade change saves time when changing blades.
- Onboard blade storage for 5 extra blades.
- Lanyard hole for easy attachment to the Milwaukee safety range to allow use at heights.



Description	Pack quantity	Min. order quantity	Article Number	EAN Code
① Compact sliding utility knife	1	1	4932492379	4058546417468
② Sliding utility knife	1	1	4932492378	4058546417451

Self-retracting safety knife

- Self-retract mechanism: Retracts blade when the button is released. Blade storage holds up to 5 blades conveniently inside the handle.
- Tool-free blade change: Saves time changing blades. Thumb-screw mechanism allows to change the blade quickly and without any extra tools.
- Heavy Duty: Durable full metal body.



Description	Pack quantity	Min. order quantity	Article Number	EAN Code
Self-retracting safety knife	1	1	4932471360	4058546289881

General purpose utility blades

- Iron carbide deposited metal for longer lifetime.
- Optimised cutting angle geometry for sharpness.
- Extra ground cutting edge for cleaner cuts.
- Blades are protected and easily accessible from storage box.

Description	Total length (mm)	Height (mm)	Pack quantity	Min. order quantity	Article Number	EAN Code
① General purpose utility knife blades	62	19	50	1	48221950	045242344444
② Hook utility knife blades	62	19	50	1	48221905	045242268061
③ Carton utility knife blades (rounded)	62	19	5	1	48221934	045242286980



Snap knives

- Metal lock* for maximum durability and longer lifetime.
- Lock with a speed thread* that allows faster blade adjustment.
- Auto-lock slide** for faster blade adjustment.
- Snap-off cap pocket clip** snaps off blade segments.
- Overmolded handle offers a slip resistant grip and is an acetone resistant.
- Iron carbide blade for longer lifetime, increased sharpness and clean cut finish.

Description	Blade width (mm)	No. blade points	Pack quantity	Min. order quantity	Article Number	EAN Code
① Snap knife 9 mm	9	13	1	1	48221960	045242296811
② Snap knife 18 mm	18	8	1	1	48221961	045242296798
③ Snap knife 25 mm	25	7	1	1	48221962	045242296828

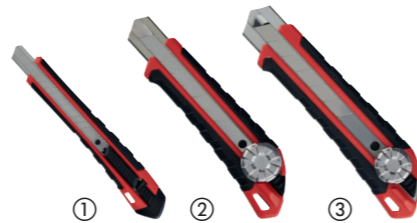

Snap blades

- Robust re-usable storage dispenser with easy access to blades.
- Optimized cutting angle geometry for sharpness and improved cutting precision.
- Iron carbide metal for longer life.
- Precise ground cutting edges for cleaner cuts.

Description	Blade width (mm)	No. blade points	Pack quantity	Min. order quantity	Article Number	EAN Code
① Snap blades 9 mm	9	13	10	1	4932480106	4058546403911
② Snap blades 18 mm	18	8	10	1	4932480107	4058546403928
③ Snap blades 25 mm	25	7	10	1	4932480108	4058546403935

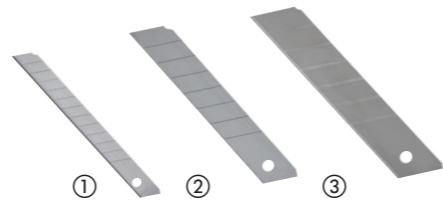

Compact knife sharpener

- Three sharpening styles for heavier, lighter and serrated blade sharpening.
- Finger loop hole for easier holding and more control.
- A magnet for convenient storage.
- High contrast ID markings in the front and back for easier readability.
- Versatile use for knives and scissors.
- Lanyard hole for easy attachment to the Milwaukee safety range to allow use at heights.



Description	Pack quantity	Min. order quantity	Article Number	EAN Code
Compact knife sharpener	1	6	4932478562	4058546347550

PVC saw

- All-metal handle design for best-in-class durability.
- Tool free blade change: up to 10x faster blade change.
- Overmold handle for increased comfort.
- Compact design.

Description	Pack quantity	Min. order quantity	Article Number	EAN Code
PVC saw	1	1	48220212	045242467518
PVC saw replacement blade	1	1	48220222	045242467532



Compact hacksaw

- Tool free blade change for changing blades up to 10x faster.
- Compact design, ideal for versatile cutting in tight spaces.
- Adjustable blade length for easier flush cutting.
- Rubber overmold grip for increased comfort.
- Accepts 12" blades.
- Supplied with 10" / 24 Tpi blade.

Description	Pack quantity	Min. order quantity	Article Number	EAN Code
Compact hacksaw	1	1	48220012	045242204571



Folding jab saw

- Enlarged handle end for easier and comfortable plunging.
- Accepts all 150mm SAWZALL™ blades and is compatible with all SAWZALL™ reciprocating saw blades.
- Tool free blade change.
- Folding blade for easier and safer storage.

Description	Blade length (mm)	Pack quantity	Min. order quantity	Article Number	EAN Code
Folding jab saw	150	1	1	4932492812	4058546476830



Hacksaw

- Tough metal frame, supports higher tension (25,000 PSI / 250 lbs).
- Overmould handle ensures secure grip and user comfort.
- Internal blade storage for extra blades.
- Supplied with 12" / 24 Tpi blade.

Description	Pack quantity	Min. order quantity	Article Number	EAN Code
Hacksaw	1	1	48220050	045242362226
Hacksaw replacement blades	10	5	4932493923	4058546510831



Rasping jab saw

- 150 mm plaster / drywall blade: Extra strong thicker blade making it more resistant for plunge cuts.
- Coated for corrosion protection.
- Built in rasping holes: Allows user to rapidly expand holes or smooth rough edges.



Description	Pack quantity	Min. order quantity	Article Number	EAN Code
① Rasping jab saw	1	1	4932479783	4058546375775
② Drywall kit (2pc)	2	1	4932479784	4058546375782

Jobsite scissors

- Iron carbide cutting edge for maximum durability. Longer lifetime vs. stainless steel.
- Chrome plated blades for maximum rust protection.
- All metal core: Full metal handle construction to protect from drops and handle breakage.
- Bolt lock technology protects blades from loosening to ensure precise cutting.
- Large handle loops for use with gloves.
- Index finger groove for more comfort.
- Laser edged ruler markings on the blade allows to measure and cut in one go.
- Jobsite offset scissors with micro-serrated blades for maximum durability and better grip.
- Jobsite offset scissors with 60°-offset head allows to keep hand above cutting material.



Description	Total length (mm)	Blade length (mm)	Weight (g)	Pack quantity	Min. order quantity	Article Number	EAN Code
① Straight scissors	230	95	180	1	1	4932479409	4058546372033
② Offset scissors	240	115	230	1	1	4932479410	4058546372040

Electricians Scissors

- Cable cutting groove for greater leverage.
- Rounded groove allows for easy wire stripping.
- Cable crimper for crimps up to 6 mm.
- Adjustable tightening screw allows to set desired resistance.
- Tool holder with belt strap for easy storage.



Description	Pack quantity	Min. order quantity	Article Number	EAN Code
Electricians Scissors	1	1	4932478620	4058546348137

Aviation Snips

- Thumb and forefinger slots for increased comfort and less fatigue. Allows user to push through sheet metal with ease with less risk of cutting oneself.
- Serrated cutting edges prevent slippage when cutting.
- Less hand fatigue when cutting thicker materials. Design with compound leverage action.
- Torsion spring opens jaws automatically during cutting for faster cutting action and less fatigue work.
- Chrome plated rust protected forged blades for increased lifetime. Extra hardened to 65 HRC.
- Made from forged alloy steel for best durability – Cr Steel.
- One hand locking mechanism.
- Flush slimline design for non-snagging in material.
- Triple cutting direction identification – on the head, handle and by colour coded handle.
- Ergonomic and durable overmoulded grips add comfort and last longer.
- Aviation snips: For short, straight and shaped cuts. Ideal for narrow radius cuts and notch cuts.
- Offset snips: For long continuous straight or curved cuts. 45° offset keeps users hand away from the cutting material.
- Extra long aviation snips: For longer and straighter cuts in one go.

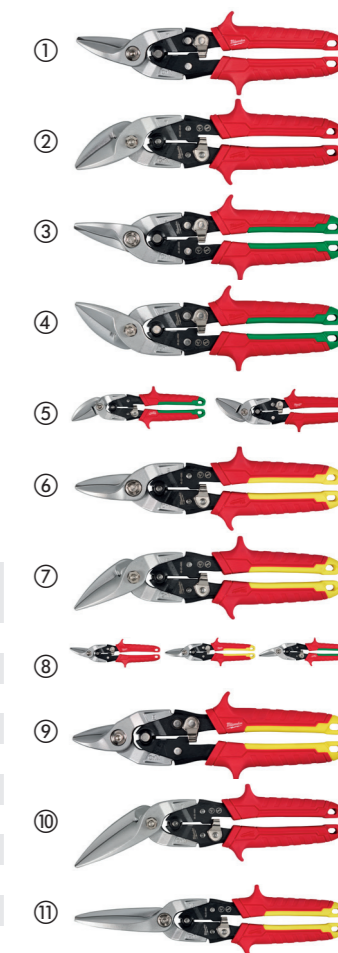

Description	Colour code	Pack quantity	Min. order quantity	Article Number	EAN Code
① Left Cutting Aviation Snips	Red	1	1	4932499011	4058546528805
② Left Cutting Offset Aviation Snips	Red	1	1	4932499013	4058546528829
③ Right Cutting Aviation Snips	Green	1	1	4932499014	4058546528836
④ Right Cutting Offset Aviation Snips	Green	1	1	4932499016	4058546528850
⑤ 2 pc Offset Aviation Snip Set	-	2	1	4932499017	4058546528867
⑥ Straight Cutting Aviation Snips	Yellow	1	1	4932499018	4058546528874
⑦ Straight Cutting Offset Aviation Snips	Yellow	1	1	4932499019	4058546528881
⑧ 3 pc Aviation Snip Set	-	3	1	4932499020	4058546528898
⑨ Bulldog Aviation Snips	Yellow	1	1	4932499010	4058546528799
⑩ Long Cut Offset Left Aviation Snips	Yellow	1	1	4932499022	4058546528911
⑪ Long Straight Aviation Snips	Yellow	1	1	4932499021	4058546528904



Mini copper tubing cutters

- Proprietary adjustment mechanism.
- Chrome rollers for added durability and extended performance provide best in class rust protection.
- Easy grip knob allows faster adjustment and easier one handed use.
- Compact design to cut pipes in restricted areas.



Description	Max. cutting capacity in copper pipe (mm)	Pack quantity	Min. order quantity	Article Number	EAN Code
Mini copper tubing cutter 15 mm	3 - 15	1	1	48229250	045242521210
Mini copper tubing cutter 22 mm	3 - 22	1	1	48229258	045242521258
Mini copper tubing cutter 28 mm	3 - 28	1	1	48229251	045242521227



Constant swing copper tubing cutters

- Constant swing copper tubing cutters are engineered for straighter, cleaner cuts.
- 4 roller design delivers accurate cuts and prevents walking.
- Chrome rollers for added durability and extended performance provide best in class rust protection.
- Smooth adjustment mechanism.
- On-board reamer enables fast, easy deburring.
- A spare wheel is integrated in the knob.



Description	Max. cutting capacity in copper pipe (mm)	Pack quantity	Min. order quantity	Article Number	EAN Code
Constant swing copper tubing cutter 28 mm	3 - 28	1	1	48229259	045242521265
Constant swing copper tubing cutter 42 mm	3 - 42	1	1	48229252	045242521234
Constant swing copper tubing cutter 67 mm	16 - 67	1	1	48229253	045242521241
Reaming blades		3	1	48224257	045242356263

Tubing cutter blades

- Replacement blades for tubing cutters.

Description	Pack quantity	Min. order quantity	Article Number	EAN Code
Tubing cutter blades for copper	2	1	48224256	045242356256



Reaming pen

- Provides easy deburring of copper tubing and PVC.
- All-metal design for durability through demanding jobsite use.
- Heat treated and black oxide coated blade for extended life.
- A slide resistant clip allows easy storage in the users pocket or tool bag for quick access.



Description	Pack quantity	Min. order quantity	Article Number	EAN Code
Reaming pen	1	1	48224255	045242356249

Plastic cutter

- Cuts PEX, PB, MDP, PE, plastic electrical conduits, pneumatic pipe, plastic overflow pipe, rubber hoses, silicon hoses up to Ø 25 mm.
- V-shaped blade allows quick and straight cuts; prevents crushing of material.
- Replaceable stainless steel blade.
- Robust construction: Metal core from the head to the handles for maximum lifetime.
- One handed locking mechanism, tool remains closed while in pouch, spring loaded but easy opening.
- Corrosion resistant head.



Description	Max. capacity tube & pipe (mm)	Pack quantity	Min. order quantity	Article Number	EAN Code
Plastic Cutter	25	1	1	4932479407	4058546372019
Plastic cutter blade replacement	-	1	1	4932479408	4058546372026

Ratcheting PVC cutter

- Durable stainless steel rust proof blade for more cuts.
- Comfortable handle adds working comfort.
- Quick blade release adds working speed.
- One-handed metal lock.
- Lanyard hole, improves working security.
- Blades are replaceable.
- Suitable for: PVC, CPVC, PEX, PP, PB, PVDF, PE.



Description	Max. capacity tube & pipe (mm)	Pack quantity	Min. order quantity	Article Number	EAN Code
① Ratcheting PVC cutter 42 mm	42	1	1	4932464172	4058546221171
Ratcheting PVC cutter 60 mm	63	1	1	4932464173	4058546221188
② Ratcheting PVC cutter blade 42 mm		1	1	48224211	045242477012
Ratcheting PVC cutter blade 60 mm		1	1	48224216	045242477036

Cable cutter

- Best-in-class cut quality: Bevelled jaw heads for accurate, smooth cable shearing.
- Comfort grips: More comfortable than dipped plastic. Grips will not peel.
- Forged design: Tool durability in abusive environments.
- Rust protection: Black oxide finish protects from rust.



Description	Pack quantity	Min. order quantity	Article Number	EAN Code
Cable cutter	1	1	48226104	045242356140

Bolt cutters

- Forged steel blades for strong and durable cutting edge.
- Comfort grip handles will not peel or slide off.
- Blade adjustment screw ensures high performance and longer life.
- Lanyard holes.

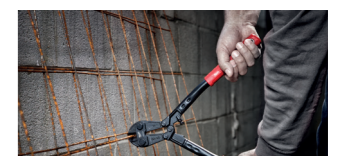

Description]	Blade width (mm)	Cutting capacity for HRC 31 materials (Max. Ø mm)	Cutting capacity for HRC 48 materials (Max. Ø mm)]	Pack quantity	Min. order quantity	Article Number	EAN Code
14" bolt cutter	13	8	5	1	1	4932464827	4058546227722
24" bolt cutter	13	11	8	1	1	4932464826	4058546227715

Extendable bolt cutters

- POWERMOVE™ handles extend for easier cuts in tough applications.
- Forged steel blades for strong and durable cutting edge.
- Pivoting head for angle adjustment.
- Comfort grip handles will not peel or slide off.
- Lanyard holes.



Description	Blade width (mm)	Cutting capacity for HRC 31 materials (Max. Ø mm)	Cutting capacity for HRC 48 materials (Max. Ø mm)	Pack quantity	Min. order quantity	Article Number	EAN Code
14" / 18" extendable bolt cutter	13	8	5	1	1	4932464850	4058546227951
24" / 30" extendable bolt cutter	13	11	8	1	1	4932464851	4058546227968



Packout Tap and Die Set

NEW

- Hex-LOK™ 2-in-1 Handle is the most versatile threading solution designed for tap and die threading.
- Hex-LO™ 2-in-1 Handle is compatible with 1" hex dies & MILWAUKEE™ Tap Collet.
- Hex-LOK™ 2-in-1 Handle compatibility allows for easy snap in and out, tool-free die and collet changes.
- Includes precision machined threading accessories and handles for the most common applications.
- Designed for use in metal materials including mild steel, brass and aluminum.
- High carbon chromium bearing steel for durability.
- Black Oxide coated taps and dies for corrosion resistance.
- Taps and dies feature long lasting laser etch for the clearest markings.



Description	Pack quantity	Min. order quantity	Article Number	EAN Code
38 pc Metric Tap & Die Packout™ Set w/ Hex-LOK™ 2-in-1 Handle	38	1	4932498721	4058546525903

Flute Plug Taps M3-0.50 mm, M4-0.70 mm, M4-0.75 mm, M5-0.80 mm, M5-0.90 mm, M6-1.00 mm, M7-1.00 mm, M8-1.00 mm, M8-1.25mm, M9-1.00 mm, M9-1.25 mm, M10-1.25 mm, M10-1.50mm, M11-1.50 mm, M12-1.50 mm, M12-1.75 mm / 1" Hex Threading Dies M3-0.50 mm, M4-0.70 mm, M5-0.80 mm, M5-0.90 mm, M6-1.00 mm, M7-1.00 mm, M8-1.00 mm, M8-1.25mm, M9-1.25 mm, M10-1.25 mm, M10-1.50mm, M11-1.50 mm, M12-1.50 mm, M12-1.75 mm / Tap Collet / Sliding T-Handle / 0.35-3.00 mm Metric Thread Pitch Gauge / Hex-LOK™ 2-in-1 Handle

Nail Puller

- Dimpler allows for easy nail removal with limited damage to surface.
- Low profile claw to reach the tightest of nails.
- Handle grip greatly reduces vibration.



Description	Length (cm)	Pack quantity	Min. order quantity	Article Number	EAN Code
9" nail puller	22.86	1	1	4932478249	4058546344269
10" nail puller	25.40	1	1	4932478250	4058546344276
12" nail puller	30.48	1	1	4932478251	4058546344283



Trim Puller

- Low profile trim claw to easily slide between trim/ skirting boards and walls.
- Dimpler allows for easy nail removal with limited damage to surface.
- Handle grip greatly reduces vibration.



Description	Length (cm)	Pack quantity	Min. order quantity	Article Number	EAN Code
10" trim puller	25.40	1	1	4932478252	4058546344290

Wrecking Bar

- Beveled edge improves leverage and accessibility when pulling nails, lifting or prying.
- Nail/ staple puller easily removes nails and staples without damaging flooring or surrounding materials.
- Reinforced strikable tongue for extra material penetration using a hammer.



Description	Length (cm)	Pack quantity	Min. order quantity	Article Number	EAN Code
12" wrecking bar	30.48	1	1	4932478253	4058546344306
15" wrecking bar	38.1	1	1	4932478254	4058546344313
21" wrecking bar	53.3	1	1	4932492778	4058546476496

Steel RIP claw hammer

- Shockshield grip reduces peak vibration.
- Straight/RIP claw for prying and demolition work.
- Magnetic nail starter for safer application.
- Side nail puller.
- I-Beam handle construction resists bending in prying applications.
- Precise balance for better handling.



Description	Pack quantity	Min. order quantity	Article Number	EAN Code
16oz Steel RIP claw hammer	1	1	4932478653	4058546348465
20oz Steel RIP claw hammer	1	1	4932478654	4058546348472

Steel curved claw hammer

- Shockshield grip reduces peak vibration.
- Curved claw hammer reduces damage when pulling nails.
- Magnetic nail starter for safer application.
- Side nail puller.
- I-Beam handle construction resists bending in prying applications.
- Precise balance for better handling.



Description	Pack quantity	Min. order quantity	Article Number	EAN Code
16oz Steel curved claw hammer	1	1	4932478655	4058546348489
20oz Steel curved claw hammer	1	1	4932478656	4058546348496

Hickory curved claw hammer

- Hickory handle providing low vibration
- Curved claw hammer reduces damage when pulling nails
- Magnetic nail starter for safer application
- Precise balance for better handling



Description	Pack quantity	Min. order quantity	Article Number	EAN Code
16oz Hickory curved claw hammer	1	1	4932478659	4058546348526
20oz Hickory curved claw hammer	1	1	4932478660	4058546348533

Hickory engineers hammer

- Hickory handle providing low vibration
- Reinforced head connection for added durability
- Precise balance for better handling
- DIN 1041



Description	Pack quantity	Min. order quantity	Article Number	EAN Code
200g Hickory engineers hammer	1	1	4932478666	4058546348595
300g Hickory engineers hammer	1	1	4932478667	4058546348601
500g Hickory engineers hammer	1	1	4932478668	4058546348618
800g Hickory engineers hammer	1	1	4932478669	4058546348625
1000g Hickory engineers hammer	1	1	4932478670	4058546348632

Fiberglass Cross-Peen Hammer

NEW

- Longer handle for controlled strikes and additional power.
- Reinforced overstrike protection for more support at the most common failure point.
- High strength fiberglass core provides increased durability and power.
- Overmold handle for increased grip and reduced vibration.
- Lanyard hole for easy attachment to the Milwaukee safety range to allow use at heights.



Description	Pack quantity	Min. order quantity	Article Number	EAN Code
1.13kg / 2.5 lbs Fiberglass Cross-Peen Hammer	1	1	4932498306	4058546521752
1.81kg / 4 lbs Fiberglass Cross-Peen Hammer	1	1	4932498308	4058546521776

Fiberglass Sledge Hammer

NEW

- Longer handle for controlled strikes and additional power.
- Reinforced overstrike protection for more support at the most common failure point.
- High strength fiberglass core provides increased durability and power.
- Overmold handle for increased grip and reduced vibration.
- Lanyard hole for easy attachment to the Milwaukee safety range to allow use at heights.



Description	Pack quantity	Min. order quantity	Article Number	EAN Code
1.13kg / 2.5 lbs Fiberglass Sledge Hammer	1	1	4932498305	4058546521745
1.81kg / 4 lbs Fiberglass Sledge Hammer	1	1	4932498307	4058546521769

Club hammer

NEW

- **Dual Face Versatility:** Milled face provides additional grip and minimizes movement of face when striking chisels or large nails, the smooth face prevents damage to struck objects.
- **Reinforced Overstrike Protection:** Increases durability in the most common failure point.
- **Fiberglass handle with over molded grip:** Provides durability with improved grip capacity and comfort.
- **Lanyard Hole:** Easily comply with safety regulations working at height.



Description	Pack quantity	Min. order quantity	Article Number	EAN Code
1.36 kg / 3 lbs club hammer	1	1	4932478255	4058546344320
0.91 kg / 2 lbs Club Hammer	1	1	4932498304	4058546521738

Steel ball peen hammer

- SHOCKSHIELD™ grip reduces peak vibration.
- Precise balance for better handling and control.
- I-Beam handle construction resists bending.
- Strong steel head prevents chipping on contact.
- Durable grip handle with an anti-slip design.



Description	Weight (g)	Weight (oz)	Pack quantity	Min. order quantity	Article Number	EAN Code
450g Ball peen hammer	450	16	1	1	4932492346	4058546417130
680g Ball peen hammer	680	24	1	1	4932492347	4058546417147

Dead blow ball peen hammer

- Precision balanced design and steel shot-filled head for optimised control.
- Durable metal faces preventing chipping on contact.
- Steel reinforced handle for higher durability.
- Over molded handle for more control and better grip.



Description	Weight (g)	Weight (oz)	Pack quantity	Min. order quantity	Article Number	EAN Code
450g Dead blow ball peen hammer	450	16	1	1	4932492348	4058546417154
907g Dead blow ball peen hammer	907	32	1	1	4932492349	4058546417161

Dead blow hammer

- Steel shot-filled head for increased rebound reduction and maximised impact.
- High-performance cover preventing damage to surfaces.
- Precision balanced design and over molded handle for more control and better grip.
- Steel reinforced handle for higher durability.



Description	Weight (g)	Weight (oz)	Pack quantity	Min. order quantity	Article Number	EAN Code
790g Dead blow hammer	790	28	1	1	4932492350	4058546417178
1360g Dead blow hammer	1360	48	1	1	4932492351	4058546417185

Beveled Edge Chisels

- All metal core for maximum durability.
- Metal striking cap for a longer handle life.
- Permanent size markings on the blade and handle for quick identification.
- Blade storage for safe transportation or storage.

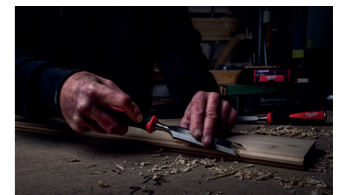

Description	Pack quantity	Min. order quantity	Article Number	EAN Code
Beveled Edge Chisel 6mm	1	1	4932479892	4058546376864
Beveled Edge Chisel 12mm	1	1	4932479893	4058546376871
Beveled Edge Chisel 19mm	1	1	4932479894	4058546376888
Beveled Edge Chisel 25mm	1	1	4932479895	4058546376895
① Beveled Edge Chisel 32mm	1	1	4932479896	4058546376901
② Beveled Edge Chisel Set 4pc 6mm, 12mm, 19mm, 25mm	4	1	4932479897	4058546376918

L-Form hex key sets

- Twist and lock case for easy access to keys.
- Ball end for up to 30° access to screw.
- Size identification to easily identify the key.
- Lanyard hole for easy attachment to the Milwaukee lanyard range allowing use at height.



Description	Pack quantity	Min. order quantity	Article Number	EAN Code
① Hex Keys 1.5, 2, 2.5, 3, 4, 5, 6, 8, 10mm	9	1	4932478621	4058546348144
Hex Key - 1.5mm	1	1	4932492409	4058546417765
Hex Key - 2mm	1	1	4932492410	4058546417772
Hex Key - 2.5mm	1	1	4932492411	4058546417789
Hex Key - 3mm	1	1	4932492412	4058546417796
Hex Key - 4mm	1	1	4932492413	4058546417802
Hex Key - 5mm	1	1	4932492414	4058546417819
Hex Key - 6mm	1	1	4932492415	4058546417826
Hex Key - 8mm	1	1	4932492416	4058546417833
Hex Key - 10mm	1	1	4932492417	4058546417840
② Compact Hex Key 9pc Set 1.5, 2, 2.5, 3, 4, 5, 6, 8, 10mm	9	1	4932492399	4058546417666
Compact Hex Key - 1.5mm	1	1	4932492400	4058546417673
Compact Hex Key - 2mm	1	1	4932492401	4058546417680
Compact Hex Key - 2.5mm	1	1	4932492402	4058546417697
Compact Hex Key - 3mm	1	1	4932492403	4058546417703
Compact Hex Key - 4mm	1	1	4932492404	4058546417710
Compact Hex Key - 5mm	1	1	4932492405	4058546417727
Compact Hex Key - 6mm	1	1	4932492406	4058546417734
Compact Hex Key - 8mm	1	1	4932492407	4058546417741
Compact Hex Key - 10mm	1	1	4932492408	4058546417758



L-Form Torx Key Set

- Unique patented twist and lock function case to allow easy access to keys.
- Torx ball end allows for 25° access to any torx screw.
- Size labels directly at the keys for easy and quick identification of the tool.
- Long keys for extra reach in hard-to-reach spaces.
- Lanyard hole for easy attachment to the Milwaukee safety range to allow use at heights.

Description	Pack quantity	Min. order quantity	Article Number	EAN Code
① 9 PC L-Form Torx Key Set T8, T9, T10, T15, T20, T25, T27, T30, T40	9	1	4932492693	4058546475642
Torx Key - T8	1	1	4932492694	4058546475659
Torx Key - T9	1	1	4932492695	4058546475666
Torx Key - T10	1	1	4932492696	4058546475673
Torx Key - T15	1	1	4932492697	4058546475680
Torx Key - T20	1	1	4932492698	4058546475697
Torx Key - T25	1	1	4932492699	4058546475703
Torx Key - T27	1	1	4932492700	4058546475710
Torx Key - T30	1	1	4932492701	4058546475727
Torx Key - T40	1	1	4932492702	4058546475734
② 9 PC compact L-form Torx key set T8, T9, T10, T15, T20, T25, T27, T30, T40	9	1	4932492703	4058546475741
Compact torx key - T8	1	1	4932492704	4058546475758
Compact torx key - T9	1	1	4932492705	4058546475765
Compact torx key - T10	1	1	4932492706	4058546475772
Compact torx key - T15	1	1	4932492707	4058546475789
Compact torx key - T20	1	1	4932492708	4058546475796
Compact torx key - T25	1	1	4932492709	4058546475802
Compact torx key - T27	1	1	4932492710	4058546475819
Compact torx key - T30	1	1	4932492711	4058546475826
Compact torx key - T40	1	1	4932492712	4058546475833



L-form hex key set

- Pivoting key holder for easy access to keys.
- Ball end for up to 30° access to screw.
- High contrast size markings to easily identify the key.
- Easy key ID with lasting laser etched markings.
- Offset slots for quick key access.

Description	Pack quantity	Min. order quantity	Article Number	EAN Code
13pc Imperial L-form hex key set $\frac{3}{16}$, $\frac{5}{16}$, $\frac{1}{4}$, $\frac{1}{2}$, $\frac{3}{8}$, $\frac{5}{32}$, $\frac{3}{16}$, $\frac{1}{8}$, $\frac{1}{16}$, $\frac{3}{32}$, $\frac{1}{8}$, $\frac{1}{16}$, 0.05"	1	1	4932493615	4058546484866



Folding Key Sets

- Foldable keys enable easy access & storage solution
- High contrast size callouts for quick and easy identification
- Ergonomically handle provides comfortable and secure grip
- Metal housing for increased durability

Description	Length (mm)	Pack quantity	Min. order quantity	Article Number	EAN Code
① 8pc Metric folding hex key set 1.5mm, 2mm, 2.5mm, 3mm, 4mm, 5mm, 6mm, 8mm	118	1	1	4932480978	4058546412630
② 8pc Folding Torx key set T9, T10, T15, T20, T25, T27, T30, T40	118	1	1	4932480979	4058546412647
③ 9pc Imperial folding hex key set $\frac{3}{16}$, $\frac{1}{2}$, $\frac{1}{4}$, $\frac{1}{8}$, $\frac{3}{16}$, $\frac{1}{2}$, $\frac{3}{16}$, $\frac{1}{2}$, $\frac{1}{4}$	116	1	1	4932493614	4058546484859



Tri-lobe screwdrivers

- Comfortable Tri-Lobe handle optimized for maximum user comfort and high torque applications.
- Permanent visible ID markings allows for quick tool identification.
- Lanyard hole for easy attachment to a safety system.
- Hardened magnetic tips for maximum durability and fastener retention.
- Anti role, 3 sided collar on the handle
- Wrench ready shank allows extra leverage to be applied.

Description	Pack quantity	Min. order quantity	Article Number	EAN Code
① Tri-lobe screwdriver set 1 (6 pc) PZ1 / PZ2 / SL3 / SL4 / SL5.5 / SL6.5	6	1	4932471806	4058546297053
② Tri-lobe screwdriver set 2 (6 pc) PH1 / PH2 / SL3 / SL4 / SL5.5 / SL6.5	6	1	4932471807	4058546297060
Tri-lobe screwdriver set 3 (10 pc) PZ1 / PZ2 / PH1 / PH2 / SL3 / SL5.5 / SL6.5 / SL8 / PH2X45 / SL6.5 x 45	10	1	4932471808	4058546297077
④ Tri-lobe screwdriver set 4 (12 pc) PZ0 / PZ1 / PZ2 / PH0 / PH1 / PH2 / SL2.5 / SL4 / SL5.5 / SL6.5 / SL6.5 / SL8	12	1	4932472003	4058546323998
⑤ Tri-lobe screwdriver Torx set (6 pc) T10 / T15 / T20 / T25 / T30 / T40	6	1	4932471809	4058546297084
⑥ Tri-lobe screwdriver stubby set (2 pc) PZ2 x 45mm / SL6.5 x 45mm	2	1	4932471810	4058546297091

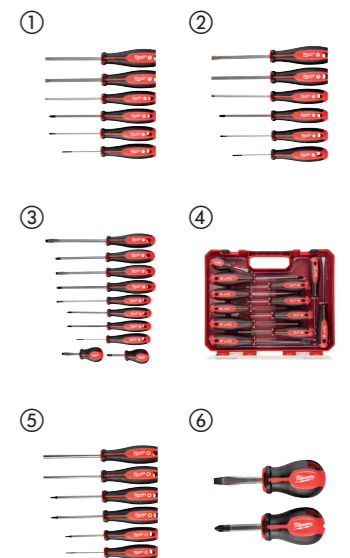

Tri-lobe demolition screwdriver

- Hammer ready strike caps.
- All metal core.
- Wrench ready shank.
- Comfortable Tri-Lobe handle.



Description	Pack quantity	Min. order quantity	Article Number	EAN Code
Tri-lobe demolition screwdriver set PH2 / SL7.9 mm	2	1	4932471872	4058546297718

Demolition driver

- Hardened all metal core giving maximum shank durability.
- Multiple striking caps to give user more force when prying and chiseling.



Description	Length (mm)	Pack quantity	Min. order quantity	Article Number	EAN Code
Demo driver	287	1	1	4932480975	4058546412609

Precision screwdrivers

- All metal core for improved durability.
- 360° rotating back cap.
- Chrome plated shanks increase tool life by reducing corrosion.
- Durable case with robust zipper included to store tools.
- Longer shanks for improved visibility and extended reach.



Description	Pack quantity	Min. order quantity	Article Number	EAN Code
Precision screwdriver set (6 pc) PH00 / PH0, SL1.6 / SL2 / SL3.2 / SL4	6	1	4932471869	4058546297688
Torx precision screwdriver (6 pc) T6, T7, T8, T9, T10, T15	6	1	4932471870	4058546297695

Ratcheting multi-bit screwdriver

- In-handle bit storage for quick and easy bit access.
- Easy visible when a bit is missing.
- Removable bit holder for access in tighter spaces.
- Power-tool ready bit holder with a 1/4" reception.
- Double-sided bits in the 27 in 1 ratchet multi-bit screwdriver for widest range of applications.
- Laser engraved sizing on the bits for easier identification.

Description	Pack quantity	Min. order quantity	Article Number	EAN Code
① 8 in 1 Compact Ratcheting Multi-Bit Screwdriver PH1 / PH2 / PZ1 / PZ2 / T15 / SL 0.6x4.5 / SL 1.2x6.5	1	6	4932480581	4058546408664
② 14 in 1 Ratchet Multi-Bit Screwdriver Hex 3 mm / Hex 4 mm / Hex 5 mm / PH1 / PH2 / PZ1 / PZ2 / T10 / T15 / T20 / T25 / SL 0.8x5.5 / SL 1.2x6.5	1	6	4932480582	4058546408671
③ 27 in 1 Ratchet Multi-Bit Screwdriver Hex 2 mm & Hex 3mm / Hex 2.5mm & Hex 4mm / Hex 5mm & Hex 6mm / PH0 & SL 1.2x6.5 / PH1 & SL 0.6x4.5 / PH2 & SL 0.5x5.0 / PH3 & SL 0.8x5.5 / T10 & T15 / T20 & T30 / PZ1 & T25 / PZ2 & T27 / PZ3 & T40 / Hex 1.5mm & T9	1	6	4932480583	4058546408688
④ 2 pc Ratcheting and Compact Ratcheting Multi-Bit Screwdriver Kit 14 in 1 Ratchet Multi-Bit Screwdriver - 4932480582, 8 in 1 Compact Ratcheting Multi-Bit Screwdriver - 4932480581	1	6	4932492811	4058546476823



Multi-Bit screwdriver

NEW

- In-handle bit storage for quick and easy bit access.
- Easy visible when a bit is missing.
- Removable bit holder for access in tighter spaces.
- Power-tool ready bit holder with a 1/4" reception.
- Double-sided bits in the 27 in 1 multi-bit screwdriver for widest range of applications. Laser engraved sizing on the bits for easier identification.

Description	Pack quantity	Min. order quantity	Article Number	EAN Code
① 8 in 1 Compact Multi-Bit Screwdriver PH1 / PH2 / PZ1 / PZ2 / T15 / SL 0.6x4.5 / SL 1.2x6.5	1	6	4932492807	4058546476786
② 14 in 1 Multi-Bit Screwdriver Hex 3 mm / Hex 4 mm / Hex 5 mm / PH1 / PH2 / PZ1 / PZ2 / T10 / T15 / T20 / T25 / SL 0.8x5.5 / SL 1.2x6.5	1	6	4932492806	4058546476779
③ 14 in 1 Torx Multi-Bit Screwdriver PH1 / PH2 / T6 / T7 / T8 / T9 / T10 / T15 / T20 / T25 / T27 / T30 / T40	1	6	4932492810	4058546476816
④ 14 in 1 Shockwave Multi-Bit Screwdriver Hex 3mm/ Hex 4mm/ Hex 5mm/ PH1 / PH2 / PZ1 / PZ2 / T10 / T15 / T20 / T25 / SL 0.8x5.5 / SL 1.2x6.5	1	1	4932498174	4058546520434
⑤ 27 in 1 Multi-Bit Screwdriver Hex 2 mm & Hex 3mm / Hex 2.5mm & Hex 4mm / Hex 5mm & Hex 6mm / PH0 & SL 1.2x6.5 / PH1 & SL 0.6x4.5 / PH2 & SL 0.5x5.0 / PH3 & SL 0.8x5.5 / T10 & T15 / T20 & T30 / PZ1 & T25 / PZ2 & T27 / PZ3 & T40 / Hex 1.5mm & T9	1	6	4932492808	4058546476793

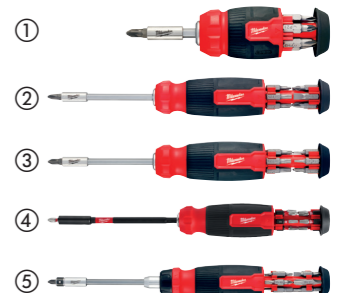

Precision Multi-Bit Screwdriver

- 360° rotating back cap, giving greater control for speed and precision and optimised for any kind of maintenance applications.
- On-board bit storage for an easy access to the bits and no carrying case needed.
- Double-sided bits for a quick bit switching.
- Non-slip grip for comfortable handling and maximum control.

Description	Pack quantity	Min. order quantity	Article Number	EAN Code
4 in 1 Precision Multi-Bit Screwdriver PH00 & SL 0.23x1.5 / PH0 & SL 0.5x3.0	1	6	4932480584	4058546408695
4 in 1 Torx Precision Multi-Bit Screwdriver T B08 & T B015 / T B07 & T B010	1	1	4932498175	4058546520441
27 in 1 Precision Multi-Bit Screwdriver PH0 & PH2 / PH00 & PH1 / PH000 & SL2.5 / SL1 & SL3 / SL2 & H1.3mm / H0.9mm & HT 2.5mm / T4 & H1.5mm / T3 & HT 2mm / T B05 & T B08 / T B07 & T B010 / T B06 & S0 / PL2 & PL5 / Y000 & Y0	1	1	4932498176	4058546520458



NEW

39 in 1 Precision Screwdriver Set

- 360° rotating back cap, giving greater control for speed and precision and optimised for any kind of maintenance applications.
- Supplied in a durable PACKOUT™ compatible case designed to get the bits out easily.
- Dual-length shank providing a compact and a standard size.
- Non-slip grip for comfortable handling and maximum control.

Description	Pack quantity	Min. order quantity	Article Number	EAN Code
39 in 1 Precision Screwdriver Set with Case PH2 / PH1 / PH0 / PH00 / PH000 / SL3.5 / SL3 / SL2.5 / SL2 / SL1.5 / SL1 / SPANNER 6 / SPANNER 4 / SO / HT3.5mm / HT3mm / HT2.5mm / HT2mm / H1.5mm / H1.3mm / H0.9mm / T B015 / T B010 / T B09 / T B08 / T B07 / T B06 / T B05 / T4 / T3 / Y1 / Y0 / Y000 / P5 / P2 / TA3 / TA2 / SQ2 / SQ1	1	1	4932498177	4058546520465



NEW

8 in 1 compact ratcheting multi-bit screwdriver

- Full metal high torque ratchet for 2x driving speed and control.
- Chrome plated marine grade rust protected bits.
- Revolver style bit storage in handle.
- Precision hardened bit tips: Durable driving tips for secure fitment and long life.

Description	Pack quantity	Min. order quantity	Article Number	EAN Code
8 in 1 compact ratcheting multi-bit screwdriver PH1 / PH2 / PZ1 / PZ2 / T15 / SL4.8 / SL6.4	1	1	4932471868	4058546297671



9 in 1 ratcheting multi-bit screwdriver

- Ergonomic 152 mm long screwdriver with 1/4" Hex nut driver (in reception) and built in loop maker.
- Full metal high torque ratchet for 2x driving speed and control.
- 88 mm long power groove bits, power tool compatibility.
- Precision hardened bit tips: Durable driving tips for secure fitment and long life.

Description	Pack quantity	Min. order quantity	Article Number	EAN Code
9 in 1 ratchet multi-bit screwdriver - universal PH1 / PH2 / PZ1 / PZ2 / T15 / T20 / Slotted 0.8 x 5.5 mm	1	12	4932471598	4058546294977



HOLLOWCORE™ Magnetic Nut Drivers

- HOLLOWCORE™ unlimited depth handle for use on long threaded rod while driving and fastening.
- 6 point head for better fit on common fasteners.
- Magnetic retention driver heads for secure fitment in fastening applications.
- Wrench ready hex shank for added leverage.
- Tri-lobe handle delivers more torque during applications.
- Colour coded ID markings allow for quick tool identification on jobsite.



Description	Size (mm)	Colour code	For anchor thread size	Pack quantity	Min. order quantity	Article Number	EAN Code
① 5mm HOLLOWCORE™ Magnetic Nut Driver	5	Black	-	1	1	4932479884	4058546376789
② 5.5mm HOLLOWCORE™ Magnetic Nut Driver	5.5	Brown	M3	1	1	4932479885	4058546376796
③ 6mm HOLLOWCORE™ Magnetic Nut Driver	6	Red	M3.5	1	1	4932479886	4058546376802
④ 7mm HOLLOWCORE™ Magnetic Nut Driver	7	Orange	M4	1	1	4932479887	4058546376819
⑤ 8mm HOLLOWCORE™ Magnetic Nut Driver	8	Yellow	M5	1	1	4932479888	4058546376826
⑥ 10mm HOLLOWCORE™ Magnetic Nut Driver	10	Blue	M6	1	1	4932479889	4058546376833
⑦ 13mm HOLLOWCORE™ Magnetic Nut Driver	13	Orange	M8	1	1	4932479890	4058546376840
17mm HOLLOWCORE™ Magnetic Nut Driver	17	Green	M10	1	1	4932498571	4058546524401
HOLLOWCORE™ Magnetic Nut Driver Set - 7 pc	5, 5.5, 6, 7, 8, 10, 13	-	M3 - M8	7	1	4932479891	4058546376857

HOLLOWCORE™ Nut Drivers

- HOLLOWCORE™ unlimited depth handle for use on long threaded rod while driving and fastening.
- 6 point head for better fit on common fasteners. Wrench ready hex shank for added leverage.
- Tri-lobe handle delivers more torque during applications.
- Colour coded ID markings allow for quick tool identification on jobsite.



Description	Size (mm)	Colour code	For anchor thread size	Pack quantity	Min. order quantity	Article Number	EAN Code
① 5mm HOLLOWCORE™ Nut Driver	5	Black	-	1	1	4932492365	4058546417321
② 5.5mm HOLLOWCORE™ Nut Driver	5.5	Brown	M3	1	1	4932492366	4058546417338
③ 6mm HOLLOWCORE™ Nut Driver	6	Red	M3.5	1	1	4932492367	4058546417345
④ 7mm HOLLOWCORE™ Nut Driver	7	Orange	M4	1	1	4932492368	4058546417352
⑤ 8mm HOLLOWCORE™ Nut Driver	8	Yellow	M5	1	1	4932492369	4058546417369
⑥ 10mm HOLLOWCORE™ Nut Driver	10	Blue	M6	1	1	4932492370	4058546417376
⑦ 13mm HOLLOWCORE™ Nut Driver	13	Orange	M8	1	1	4932492371	4058546417383
17mm HOLLOWCORE™ Nut Driver	17	Green	M10	1	1	4932498572	4058546524418
HOLLOWCORE™ Nut Driver Set - 7 pc	5, 5.5, 6, 7, 8, 10, 13	-	M3 - M8	7	1	4932492372	4058546417390

Automatic Wire Stripper

- Fully automatic, self-adjusting wire stripper for all common stranded and solid wires from 0.2 mm² to 16 mm².
- Adjustable length stop from 5 mm to 25 mm for precise working.
- Integrated side cutter to cut wires up to 3 mm Cu/Al.
- The slim head design allows easier access to difficult areas.
- Two component handle design for comfortable handling and maximum force transmission.
- Locking mechanism for a safe storage and space-saving.
- Integrated name tag to customise the tool.
- Lanyard hole for easy attachment to the Milwaukee safety range to allow use at heights.



Description	Min. order quantity	Pack quantity	Article Number	EAN Code
Automatic Wire Stripper	1	1	4932498268	4058546521370



Cable Stripper

- Increased cable strip capacity for all standard round cables with a diameter of 4 mm to 28 mm.
- The adjusting wheel helps to regulate and adjust the cutting depth.
- Automatic changeover from round to longitudinal cut.
- Integrated hook blade for more versatility. Safety cap on the blade reduces the risk of injury.
- Two component handle design for comfortable handling and non-slip.

Description	Min. order quantity	Pack quantity	Article Number	EAN Code
Cable Stripper	1	1	4932498269	4058546521387



NEW

4 in 1 Multi-Purpose Stripper

- Cable stripping of all common round and flat cable. Standard round cable strip capacity with a diameter of 6 mm to 13 mm. Standard flat cable up to a width of 18mm.
- Automatic changeover from round to longitudinal cut.
- Wire stripping capacity for all standard stranded and solid wires with the sizes 0.5 mm², 0.8 mm², 1.5 mm², 2.5 mm², 4 mm², 6 mm².
- Cutting blade depth easy adjustable from 0-3mm with a lockable adjusting screw.
- Built in loop maker to bend conductors to loop.
- Ergonomically shaped handle and ridges on the housing to not slip off while working.

Description	Min. order quantity	Pack quantity	Article Number	EAN Code
4 in 1 Multi-Purpose Stripper	1	1	4932498270	4058546521394



NEW

Multi-Purpose Wire Stripper with Crimper

- Wire stripping capacity for 6 sizes from 0.75mm², 1 mm², 1.5mm², 2.5 mm², 4 mm² to 6mm².
- Wire cutter with double-sided laser hardened cutting edges for the best cut.
- Bolt cutter for M2.5, M3, M3.5, M4 and M5.
- Integrated crimper for insulated and noninsulated terminals.

Description	Min. order quantity	Pack quantity	Article Number	EAN Code
Multi-Purpose Wire Stripper with Crimper	1	1	4932493816	4058546509767



NEW

Fish tape

- High flexibility tape for easier feeding.
- Thicker tape for better pushing.
- Triple strand design, won't kink.
- Low friction case for smooth pay out.
- Square inner grip for easier winding.

Description	Length (m)	Pack quantity	Min. order quantity	Article Number	EAN Code
① Steel fish tape 7.5 m	7.5	1	1	4932472120	4058546325169
① Steel fish tape 15 m	15	1	1	4932472121	4058546325176
② Polyester fish tape 15 m	15	1	1	4932472118	4058546325145
② Polyester fish tape 30 m	30	1	1	4932472119	4058546325152



Tri-Lobe VDE screwdrivers

- VDE tested to 10,000 V and guaranteed to 1,000 V.
- Slim shank diameter for access to low lying screw applications.
- Comfortable Tri-Lobe handle optimized for maximum user comfort and high torque applications.
- Permanent visible ID markings allows for quick tool identification.
- Anti role, 3 sided collar on the handle
- Landyard hole for easy attachment to a safety system.

Description	Pack quantity	Min. order quantity	Article Number	EAN Code
Tri-Lobe VDE screwdriver - slotted 0.4 x 2.5 x 75	1	1	4932478712	4058546349059
Tri-Lobe VDE screwdriver - slotted 0.5 x 3 x 100	1	1	4932478713	4058546349066
Tri-Lobe VDE screwdriver - slotted 0.6 x 3.5 x 100	1	1	4932478714	4058546349073
Tri-Lobe VDE screwdriver - slotted 0.8 x 4 x 100	1	1	4932478715	4058546349080
Tri-Lobe VDE screwdriver - slotted 1.0 x 5.5 x 125	1	1	4932478716	4058546349097
Tri-Lobe VDE screwdriver - slotted 1.2 x 6.5 x 150	1	1	4932478717	4058546349103
Tri-Lobe VDE screwdriver - slotted 1.6 x 8 x 175	1	1	4932478718	4058546349110
Tri-Lobe VDE screwdriver PH0 x60	1	1	4932478720	4058546349134
Tri-Lobe VDE screwdriver PH1 x80	1	1	4932478721	4058546349141
Tri-Lobe VDE screwdriver PH2 x100	1	1	4932478722	4058546349158
Tri-Lobe VDE screwdriver PH3 x150	1	1	4932478723	4058546349165
Tri-Lobe VDE screwdriver PZ0 x60	1	1	4932478724	4058546349172
Tri-Lobe VDE screwdriver PZ1 x80	1	1	4932478725	4058546349189
Tri-Lobe VDE screwdriver PZ2 x100	1	1	4932478726	4058546360085
Tri-Lobe VDE screwdriver PZ3 x150	1	1	4932478727	4058546360092
Tri-Lobe VDE screwdriver T10 x60	1	1	4932478728	4058546360108
Tri-Lobe VDE screwdriver T15 x75	1	1	4932478729	4058546360115
Tri-Lobe VDE screwdriver T20 x100	1	1	4932478730	4058546360122
Tri-Lobe VDE screwdriver T25 x100	1	1	4932478731	4058546360139
Tri-Lobe VDE screwdriver T30 x100	1	1	4932478732	4058546360146
Tri-Lobe VDE screwdriver PH/S L1 x80	1	1	4932478733	4058546360153
Tri-Lobe VDE screwdriver PH/ SL2 x100	1	1	4932478734	4058546360160
Tri-Lobe VDE screwdriver PZ/ SL1 x80	1	1	4932478735	4058546360177
Tri-Lobe VDE screwdriver PZ/ SL2 x100	1	1	4932478736	4058546360184



Voltage tester 0.5 x 3 x 65	1	1	4932478719	4058546349127
① Tri-Lobe VDE screwdriver set - 5 pc PZ1 / PZ2 / SL3 / SL4 and voltage tester	1	1	4932478737	4058546360191
② Tri-Lobe VDE screwdriver PZ set - 7 pc SL2.5 / SL3 / SL4, PH2, PZ1 / PZ2 and voltage tester	1	1	4932478738	4058546360207
③ Tri-Lobe VDE screwdriver PH set - 7 pc SL2.5 / SL3 / SL4 / SL5.5 / PH1 / PH2 and voltage tester	1	1	4932478739	4058546360214
④ Tri-Lobe VDE screwdriver 12 pc set SL2.5 / SL3 / SL4 / SL5.5 / PH1 / PH2 / PZ1 / PZ2 / T10 / T15 / T20 and voltage tester	1	1	4932479095	4058546368890



Ratcheting Insulated Terminals Crimper

- 3 crimping cavities to crimp multiple size connectors with one tool. Red (0.3 - 1.0mm²), blue (1.5 - 2.5mm²) and yellow (4.0 - 6.0mm²).
- Dual-ratcheting action provides a full, complete crimp that ensures secure connections.
- High-contrast color-coded markings provides better visibility.
- Quick-release lever for increased productivity.
- Ergonomic handle designed with comfort grips that will not peel.

Description	Pack quantity	Min. order quantity	Article Number	EAN Code
Ratcheting Insulated Terminals Crimper	1	1	4932499025	4058546528942



Insulated Multi-Bit Screwdriver

- VDE (DIN EN/IEC 60900) certified tools for added security. Tested to 10,000 volts and guaranteed to 1,000 volts.
- Slim shank diameter for easier access to low lying screws.
- Compact, soft pouch included for quick and easy bit access.
- Laser engraved sizing on the bits for easier identification.
- Lanyard hole for easy attachment to the Milwaukee safety range to allow use at heights.

Description	Min. order quantity	Pack quantity	Article Number	EAN Code
① Insulated 10 in 1 Multi-Bit Screwdriver Set PH1 / PH2 / PZ1 / PZ2 / T10 / T15 / T20 / T25 / SL5.5 / SL/PZ2	1	1	4932493657	4058546485283
② Insulated 4 in 1 Torx Multi-Bit Screwdriver Set T10 / T15 / T20 / T25	1	1	4932493658	4058546485290
③ Insulated 8 in 1 Precision Multi-Bit Screwdriver Set PH00 / PH0 / PZ0 / SL2 / T6 / T7 / T8 / T10	1	1	4932493659	4058546485306

NEW



VDE pliers

- VDE (DIN EN/IEC 60900) certified tools. Tested to 10,000 volts and guaranteed to 1,000 volts. Tested against cold to -40°.
- Steel blades are fully forged, hardened and tempered for best durability. Grey titanium surface finish is non reflective and ensures maximum corrosion resistance.
- Induction hardened cutting edges to cut even the hardest of materials.
- Precision machined joint for maximum power transmission with optimum leverage for easy and effortless work.
- Ergonomic grip with softgrip for comfortable handling and good grip.



Description	Total length (mm)	Pack quantity	Min. order quantity	Article Number	EAN Code
① VDE cable cutter	160	1	1	4932464562	4058546225070
	210	1	1	4932464563	4058546225087
② VDE long round nose plier	205	1	1	4932464564	4058546225094
③ VDE long 45 deg. round nose pliers	205	1	1	4932464565	4058546225100
	145	1	1	4932464566	4058546225117
④ VDE diagonal cutter	160	1	1	4932464567	4058546225124
	180	1	1	4932464568	4058546225131
⑤ VDE heavy duty diagonal cutter	180	1	1	4932464569	4058546225148
	200	1	1	4932464570	4058546225155
⑥ VDE combination plier	165	1	1	4932464571	4058546225162
	180	1	1	4932464572	4058546225179
⑦ VDE wire stripping plier	160	1	1	4932464573	4058546225186
⑧ VDE water pump plier	240	1	1	4932464574	4058546225193
⑨ VDE plier set (3 pc) - Diagonal cutter (160 mm), long nose plier (205 mm), combi plier (180 mm)		3	1	4932464575	4058546225209

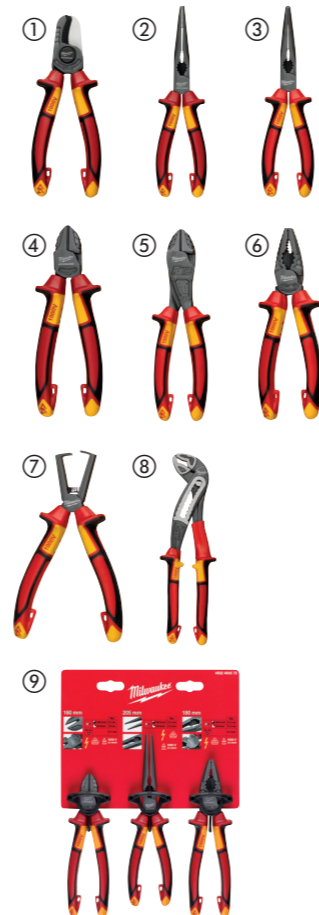

Pliers

- Precision machined joint for maximum power transmission with optimum leverage for up to 60% less effort needed.
- Induction hardened cutting edges to cut even the hardest of materials.
- Grey titanium surface finish is non reflective and ensures maximum corrosion resistance.
- Two component handle design for comfortable handling and ergonomic grip.
- The combination plier and long nose plier features an Integrated ring spanner to tighten or untighten metric bolts (M8 to M10).
- The combination plier have a Gripping zone with integrated nail bender and holder. Lanyard hole for easy attachment to the Milwaukee safety range to allow use at heights.
- The adjustable water pump plier features a push button for quick and precise adjustments on the workpiece.
- Double toothed jaw for maximum grip and Induction hardened teeth with self-locking serration to not slip on the workpiece.
- The adjustable water pump plier has an integrated nail and wire holder.



Description	Pack quantity	Min. order quantity	Article Number	EAN Code
① Combination Plier - 165mm	1	1	4932492461	4058546418281
Combination Plier - 180mm	1	1	4932492462	4058546418298
② Diagonal Cutting Plier - 160mm	1	1	4932492463	4058546418304
③ Heavy Duty Diagonal Cutting Plier - 200mm	1	1	4932492464	4058546418311
④ Long Nose Plier - 205mm	1	1	4932492465	4058546418328
⑤ 45° Long Nose Plier - 205mm	1	1	4932492466	4058546418335
⑥ Adjustable Water Pump Plier - 180mm	1	1	4932492458	4058546418250
Adjustable Water Pump Plier - 250mm	1	1	4932492459	4058546418267
Adjustable Water Pump Plier - 300mm	1	1	4932492460	4058546418274
⑦ 3 Piece Plier Set	3	1	4932492773	4058546476441

1 x Combination plier 180mm 4932492462, 1x Long nose plier 205mm 4932492465, 1 x Diagonal cutting plier 160mm 4932492463

Nipping pliers

- Iron carbide edge: Longer blade life.
- Comfort grips: More comfortable than dipped plastic. Grips will not peel.
- Smooth head: Will not mark surface during pull / pry applications.
- Forged design: Tool durability in abusive environments.
- Rust protection: Black oxide finish protect from rust.



Description	Length (mm)	Pack quantity	Min. order quantity	Article Number	EAN Code
Nipping pliers	180	1	1	48226407	045242356096

Mini Flush Cutters

- Angled head design for better access to tight spaces.
- Induction hardened cutting edges for consistent, precise cuts through thin wires and cable ties.
- Spring loaded handle for maximum efficiency and to reduce hand fatigue while using the tool.
- Rust protection increases tool life by reducing corrosion.
- Ergonomic handle designed with comfort grips that will not peel.



Description	Pack quantity	Min. order quantity	Article Number	EAN Code
Mini Flush Cutters	1	1	4932499024	4058546528935

Fencing plier

- Multi-purpose design with 6 different features including a staple puller, staple pincher, fencing wire cutter, fencing wire puller, fencing wire crimper and general purpose hammer.
- Forged head design for the toughest applications.
- Comfort grip handle design that will not peel.
- Black oxide finish protects from rust and is optimal for tough jobsite conditions.



Description	Pack quantity	Min. order quantity	Article Number	EAN Code
Fencing Plier	1	1	4932493926	4058546510862

7 in 1 wire stripping pliers

- Wire stripper : Strips wire sizes 0.75 mm², 1.0 mm², 1.5 mm², 2.5 mm², 4.0 mm², 6.0 mm².
- Wire cutter: With curved laser hardened cutting edges.
- Plier suitable for gripping and bending cables.
- Reaming head for smoothing 12 - 25 mm pipe.
- Loop maker: Built in loop maker function for wire.
- Integrated crimper.
- Integrated bolt cutter.
- One-handed swing lock: Easy one-handed use and remains locked while in pouch. Spring loaded for easy opening.
- Rust protection increases tool life by reducing corrosion.



Description	Stripping capacities (mm ²)	Cutting capacity in hard wire	Cutting capacity in cable Al and Cu (Max. Ø mm)	De-burring head (Max. Ø mm)	Pack quantity	Min. order quantity	Article Number	EAN Code
7 in 1 combination plier	0.75, 1.0, 1.5, 2.5, 4.0, 6.0	2.5	6.0	25	1	1	4932478554	4058546347475



Heavy Duty Lineman's pliers

- For universal gripping, cutting applications.
- High leverage design: Long handles for maximum cutting power and leverage.
- Deburrer: Deburring ribs on head for up to 25 mm pipe. No need for extra tools.
- Nail puller: Powerful gripping and high leverage.
- Laser hardened durable cutting edges: Cuts wire, bolts, screws and nails. Extra hardened jaws to 64 HRC.
- Serrated gripping zone for strong gripping and pulling.
- Made from Chrome Vanadium steel for best durability and good rust protection.
- Ergonomic and durable overmoulded grips add comfort and last longer.
- With crimping facility.



Cut cap. in hard wire (mm)	Cutting capacity soft wire (mm)	Total length (mm)	Weight (g)	Deburring head (Max. Ø mm)	Pack quantity	Min. order quantity	Article Number	EAN Code
3.0	4.6	250	480	25	1	1	48226100	045242342228



PVC/Oil filter pliers

- Versatile 89mm jaw capacity in a compact 229mm size, offering a solution for multiple plumbing and automotive applications
- Comfort grips that will not peel
- Forged designs for rust protection and increased durability



Description	Length (mm)	Pack quantity	Min. order quantity	Article Number	EAN Code
PVC/Oil filter pliers	229	1	1	4932492511	4058546418786



Long reach pliers

- Deep-reach cross handles for increased reach in tight spaces for best access.
- Multi-function gripping zones for grabbing a wide variety of materials such as screws, cables and round parts.
- Single-joint grip force for more control and better grip compared to double joint.
- Textured nose maintains control when grabbing and twisting with serrated nose.



Description	Length (mm)	Tip Angle (°)	Pack quantity	Min. order quantity	Article Number	EAN Code
Long reach plier - Straight	332	0°	1	1	4932492497	4058546418649
Long reach plier - 45°	326	45°	1	1	4932492498	4058546418656
Long reach pliers 2 pc ets			2	1	4932492499	4058546418663
Straight long reach plier, 45° long reach plier						



Hose grip pliers

- Deep-reach cross handles for increased reach in tight spaces for best access.
- Multi-function gripping zones for grabbing a wide variety of materials such as screws, cables and round parts.
- Single-joint grip force for more control and better grip compared to double joint.
- Rounded tips to grab hoses without damaging these.



Description	Length (mm)	Pack quantity	Min. order quantity	Article Number	EAN Code
Small diameter hose grip plier	327	1	1	4932492500	4058546418670
Medium diameter hose grip plier	324	1	1	4932492501	4058546418687
Large diameter hose grip plier	321	1	1	4932492502	4058546418694
Hose grip pliers 3 pc set		3	1	4932492503	4058546418700
Small diameter hose grip plier (8mm), medium diameter hose grip plier (12.7mm), large diameter hose grip plier (19mm)					

Circlip pliers

- Easier and quicker internal-external conversion with anti-slip grooved dial.
- All-metal convertible dial for resistance against wear and prevents reduction in joint integrity.
- Slip-resistant grips with double-dipped handles.



Description	Length (mm)	Tip	Tip Angle (°)	Diameter of circle (mm)	Pack quantity	Min. order quantity	Article Number	EAN Code
Small circlip plier - Straight	154	0.9mm	18°	9.5 - 25.4	1	1	4932492487	4058546418540
Small circlip plier - 45°	152	0.9mm	45°	9.5 - 25.4	1	1	4932492488	4058546418557
Small circlip plier - 90°	147	0.9mm	90°	9.5 - 25.4	1	1	4932492489	4058546418564
Medium circlip plier - Straight	154	1.2mm	18°	15.8 - 34.9	1	1	4932492490	4058546418571
Medium circlip plier - 45°	152	1.2mm	45°	15.8 - 34.9	1	1	4932492491	4058546418588
Medium circlip plier - 90°	147	1.2mm	90°	15.8 - 34.9	1	1	4932492492	4058546418595
Large circlip plier - Straight	188	1.8mm	18°	26.9 - 50.8	1	1	4932492493	4058546418601
Large circlip plier - 45°	186	1.8mm	45°	26.9 - 50.8	1	1	4932492494	4058546418618
Large circlip plier - 90°	179	1.8mm	90°	26.9 - 50.8	1	1	4932492495	4058546418625
Circlip pliers 9 pc set					9	1	4932492496	4058546418632
Storage case with a magnetic base, small circlip plier - straight - 0.9mm tip, small circlip plier - 45° - 0.9mm tip, small circlip plier - 90° - 0.9mm tip, medium circlip plier - straight - 1.2mm tip, medium circlip plier - 45° - 1.2mm tip, medium circlip plier - 90° - 1.2mm tip, large circlip plier - straight - 1.8mm tip, large circlip plier - 45° - 1.8mm tip, large circlip plier - 90° - 1.8mm tip								

TORQUE LOCK™ locking pliers

- TORQUE LOCK™: Faster set up and easy release when clamping flat and round material. Extra force can be applied to the TORQUE LOCK™ screw for better and more secure grip. Can also be used for hanging / storage purposes.
- Hardened jaws: Better grip force on jobsite material.
- Rust protection: Chrome plated tool increases life by reducing corrosion.
- Lever release design: Traditional release lever for jobsite convenience.
- MAXBITE™ pliers have special jaw geometry for maximum grip.

	Total length (mm)	Total length (Inch)	Jaw type	Jaw capacity flat (mm)	Jaw opening capacity for pipe (mm)	Pack quantity	Min. order quantity	Article Number	EAN Code
①	170	7	MAXBITE™	-	38	1	1	4932471730	4058546296292
②	250	10	MAXBITE™	-	50	1	1	4932471729	4058546296285
③	72	4	curved	-	18	1	1	4932493618	4058546484897
④	127	5	curved	-	26	1	1	4932472263	4058546339098
⑤	170	7	curved	-	38	1	1	4932471732	4058546296315
⑥	250	10	curved	-	51	1	1	4932471725	4058546296247
⑦	250	10	flat	30	-	1	1	4932471726	4058546296254
⑧	100	4	flat long nose	42	-	1	1	4932472262	4058546339081
⑨	150	6	flat long nose	52	-	1	1	4932471731	4058546296308
⑩	230	9	flat long nose	76	-	1	1	4932471733	4058546296322
⑪	343	12	large capacity	-	90	1	1	4932493619	4058546484903

TORQUE LOCK™



TORQUE LOCK™ locking C clamps

- TORQUE LOCK™: Faster set up and easy release when clamping flat and round materials for welding. Extra force can be applied to the TORQUE LOCK™ screw for better and more secure grip. Can also be used for hanging / storage purposes.
- Hardened jaws: Better grip force on jobsite material.
- Rust protection: Chrome plated tool increases life by reducing corrosion.
- Lever release design: Traditional release lever for jobsite convenience.

	Total length (mm)	Total length (inch)	Jaw type	Jaw capacity flat (mm)	Pack quantity	Min. order quantity	Article Number	EAN Code
①	230	9	Deep reach regular pointed pads	114	1	1	4932472257	4058546339036
②	480	18	Deep reach regular pointed pads	170	1	1	4932472259	4058546339050
③	280	11	Regular pointed pads	90	1	1	4932471728	4058546296278
④	480	18	Regular pointed pads	170	1	1	4932472260	4058546339067
⑤	230	9	Deep reach swivel pads	114	1	1	4932472258	4058546339043
⑥	280	11	Swivel pads	100	1	1	4932471727	4058546296261
⑦	480	18	Swivel pads	170	1	1	4932472261	4058546339074
⑧	152	6	Regular pointed pads	57.2	1	1	4932493617	4058546484880

TORQUE LOCK™

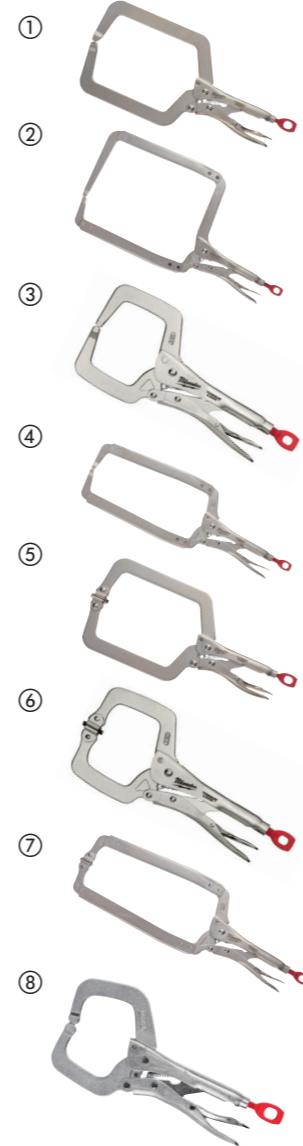

TORQUE LOCK™ locking welder's clamp

- TORQUE LOCK™ enables faster set up and easy release when clamping flat and round material. Extra force can be applied to the TORQUE LOCK™ screw for better and more secure grip. Can also be used for hanging / storage purposes.
- Special U-shaped jaws for a claw-like grip on both round and square-shaped tubing during welding.
- Hardened jaws for better grip force on jobsite material.
- Chrome plated tool increases life by reducing corrosion.

Description	Length (mm)	length (inch)	Pack quantity	Min. order quantity	Article Number	EAN Code
9" - 229mm TORQUE LOCK™ locking welder's clamp	229	9	1	1	4932493616	4058546484873

TORQUE LOCK™



TORQUE LOCK™ seamer

- TORQUE LOCK™: Faster set up and easy release when clamping flat material. Extra force can be applied to the TORQUE LOCK™ screw for better and more secure grip. Can also be used for hanging / storage purposes.
- Hardened jaws: Better grip force on jobsite material.
- Rust protection: Chrome plated tool increases life by reducing corrosion.
- Lever release design: Traditional release lever for jobsite convenience.
- The seamer makes all kinds of bendings, forming, crimping tasks with ease.
- It is ideal for holding sheet metal parts.

Description	Total length (mm)	Total length (inch)	Jaw capacity flat (mm)	Pack quantity	Min. order quantity	Article Number	EAN Code
TORQUE LOCK™ seamer	200	8	42	1	1	4932471734	4058546296339

TORQUE LOCK™



TORQUE LOCK™ chain wrench

- TORQUE LOCK™: Faster set up and easy release when clamping round material. Extra force can be applied to the TORQUE LOCK™ screw for better and more secure grip. Can also be used for hanging / storage purposes.
- Rust protection: Chrome plated tool increases life by reducing corrosion.
- Lever release design: Traditional release lever for jobsite convenience.
- Locking chain wrench holds and locks around any shape object.
- It adjusts quickly for ratchet action in either direction.

Description	Total length (mm)	Total length (inch)	Jaw opening capacity for pipe (mm)	Pack quantity	Min. order quantity	Article Number	EAN Code
TORQUE LOCK™ chain wrench	270	9	79	1	1	48223542	045242472727

TORQUE LOCK™



Inner-Outer Deburrer

NEW

- 40 hardened and ground cutting edges provides a clean, burr free, installation-ready pipe.
- Robust aluminium metal housing delivers highest durability for toughest jobsite condition.
- Ridges on the outside for an improved grip, even with gloves.
- Increased versatility in reaming all standard pipe materials. Plastic, cooper, aluminium, steel, iron, brass, stainless steel.



Description	Min. order quantity	Pack quantity	Article Number	EAN Code
Inner-Outer Deburrer 6 - 35mm	1	1	4932493812	4058546509729
Inner-Outer Deburrer 10 - 54mm	1	1	4932493813	4058546509736

Steel and aluminium pipe wrenches

- Overbite jaw for secure grip on pipes and fittings.
- Dual coil springs for maximum durability and tool life.
- Ergonomic handle for maximum comfort, won't dig into the palm.
- Hardened jaws for increased durability and better grip.
- Lanyard hole.



Description	Total length (mm)	Total length (inch)	Jaw opening capacity for pipe (mm)	Jaw opening capacity for pipe (inch)	Weight (g)	Pack quantity	Min. order quantity	Article Number	EAN Code
Aluminium pipe wrench 250 mm	250	10	38	1.5	598	1	1	48227210	045242342372
Aluminium pipe wrench 300 mm	300	12	51	2	816	1	1	48227212	045242342389
Aluminium pipe wrench 350 mm	350	14	51	2	1076	1	1	48227214	045242342396
Aluminium pipe wrench 450 mm	450	18	63	2.5	1630	1	1	48227218	045242342419
Aluminium pipe wrench 600 mm	600	24	76	3	2644	1	1	48227224	045242342426

Cheater aluminium adjustable pipe wrench

- All in one adjustable sliding handle design between 450 mm & 600 mm.
- Removable handle to 250 mm length for access to tight spaces.
- Aluminium design for lighter weight.
- Overbite jaw for secure grip on pipes and fittings.
- Ergonomic round handle for maximum comfort, won't dig into the palm.
- Hardened jaws for increased durability and better grip.



Description	Total length (inch)	Jaw opening capacity for pipe (mm)	Jaw opening capacity for pipe (inch)	Weight (g)	Pack quantity	Min. order quantity	Article Number	EAN Code
Cheater aluminium adjustable pipe wrench	10 / 18 / 24	63	2.5	2019	1	1	4932478672	4058546348656

CHEATER - adaptable pipe wrench

- 3 handle design - 10'/ 250 mm mode for tight spaces, 18'/ 450 mm mode for general purpose, 24'/ 600 mm mode for maximum leverage and reach.
- Overbite jaw for secure grip on pipes and fittings.
- Dual coil springs for maximum durability and tool life.
- Ergonomic handle for maximum comfort, won't dig into the palm.
- Ergonomic hook jaw design - for easy detachment from the workpiece.
- Hardened jaws for increased durability and better grip.
- Lanyard hole.

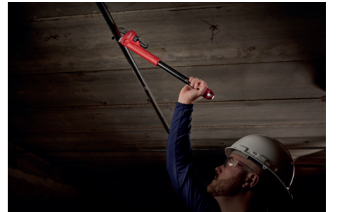

Description	Total length (mm)	Total length (inch)	Jaw opening capacity for pipe (mm)	Jaw opening capacity for pipe (inch)	Weight (g)	Pack quantity	Min. order quantity	Article Number	EAN Code
Adaptable pipe wrench	250/450/600	10/18/24	63	2.5	3243	1	1	48227314	045242342402

Adjustable wrenches

- Precision adjustment screw with accurate threads and tight tolerances. The jaws won't back off during use.
- Chrome plating for best-in-class rust protection and increased durability.
- Ergonomic rounded handle design for a comfortable fit in the hand and less pressure points on the palm.
- Slim head design for reaching into tight spaces.
- Parallel jaws won't slip or damage finish surfaces.
- Permanent lasered inch and mm markings for accurate adjustment.
- 8" adjustable wrench (48227508) has an extra wide jaw of 38 mm for increased jaw capacity in confined environments.
- Lanyard hole.



Total length (mm)	Total length (inch)	Jaw opening capacity for pipe (mm)	Jaw thickness (mm)	Tip thickness (mm)	Weight (g)	Pack quantity	Min. order quantity	Article Number	EAN Code
150	6	24.5	11.5	7,7	186	1	1	48227406	045242356225
200	8	30	14	8,7	353	1	1	48227408	045242356218
200	8	40	14	8,1	385	1	1	48227508	045242356232
250	10	36.5	16	9,9	535	1	1	48227410	045242356201
300	12	42.5	17	10,8	748	1	1	48227412	045242356195
380	15	46	22	13,5	1,470	1	1	48227415	045242356188
② Adjustable wrench twin pack 150 mm (48227406) + 250 mm (48227410)						1	2	48227400	045242358823
③ Adjustable wrench triple pack 150mm (48227406), 200mm (48227408) + 250mm (48227410)						3	1	4932493414	4058546482855

Basin wrench

- Ratchet-compatible design: Accepts 3/8" ratchet.
- Hi-leverage design: Achieve break-away torque on stuck fasteners.
- Door-knob handle: More comfortable than square.
- Easy to adjust handle: Best-in-class adjustability.



Description	Jaw size (mm)	Pack quantity	Min. order quantity	Article Number	EAN Code
Basin wrench compact	10 - 32	1	1	48227001	045242366170
Basin wrench	32 - 65	1	1	48227002	045242366187

S Jaw pipe wrench

- Made of forged chrome vanadium steel and oil hardened for durability according to DIN 5234.
- Slim, S shaped 45° angled jaws for best reach in confined areas.
- Assymetric serrated induction hardened jaws for maximum grip.
- I-Beam handle design for maximum strength.



Total length (mm)	Capacity pipe [Max. Ø mm]	Weight (g)	Pack quantity	Min. order quantity	Article Number	EAN Code
340	52	965	1	1	4932464576	4058546225216
450	67	1570	1	1	4932464577	4058546225223
550	83	3000	1	1	4932464578	4058546225230



MAX BITE™ combination spanner

- MAX BITE™ open-end grip reduces rounding and stripping.
- Rounded I-Beam handle for comfortable handling grip.
- Ink-filled labels for better visibility.
- 15° offset box for better accessibility.



Description	Total length (mm)	Pack quantity	Min. order quantity	Article Number	EAN Code
6 mm MAX BITE™ combination spanner	128	1	1	4932480197	4058546404826
7 mm MAX BITE™ combination spanner	135	1	1	4932480198	4058546404833
8 mm MAX BITE™ combination spanner	140	1	1	4932471516	4058546294151
9 mm MAX BITE™ combination spanner	150	1	1	4932471517	4058546294168
10 mm MAX BITE™ combination spanner	158	1	1	4932471518	4058546294175
11 mm MAX BITE™ combination spanner	165	1	1	4932471519	4058546294182
12 mm MAX BITE™ combination spanner	172	1	1	4932471520	4058546294199
13 mm MAX BITE™ combination spanner	180	1	1	4932471521	4058546294205
14 mm MAX BITE™ combination spanner	190	1	1	4932471522	4058546294212
15 mm MAX BITE™ combination spanner	200	1	1	4932471523	4058546294229
16 mm MAX BITE™ combination spanner	210	1	1	4932471524	4058546294236
17 mm MAX BITE™ combination spanner	225	1	1	4932471525	4058546294243
18 mm MAX BITE™ combination spanner	235	1	1	4932471526	4058546294250
19 mm MAX BITE™ combination spanner	250	1	1	4932471527	4058546294267
20 mm MAX BITE™ combination spanner	262	1	1	4932471528	4058546294274
21 mm MAX BITE™ combination spanner	272	1	1	4932471529	4058546294281
22 mm MAX BITE™ combination spanner	295	1	1	4932471530	4058546294298
23 mm MAX BITE™ combination spanner	310	1	1	4932480199	4058546404840
24 mm MAX BITE™ combination spanner	315	1	1	4932480200	4058546404857
25 mm MAX BITE™ combination spanner	340	1	1	4932480201	4058546404864
26 mm MAX BITE™ combination spanner	340	1	1	4932480202	4058546404871
27 mm MAX BITE™ combination spanner	367	1	1	4932480203	4058546404888
28 mm MAX BITE™ combination spanner	367	1	1	4932480204	4058546404895
29 mm MAX BITE™ combination spanner	393	1	1	4932480205	4058546404901
30 mm MAX BITE™ combination spanner	393	1	1	4932480206	4058546404918
32 mm MAX BITE™ combination spanner	429	1	1	4932480207	4058546404925
36 mm MAX BITE™ combination spanner	513	1	1	4932480208	4058546404932

MAX BITE™ combination spanner sets

- MAX BITE™ open-end grip reduces rounding and stripping.
- Rounded I-Beam handle for comfortable handling grip.
- Optimised storage: 7 pc set with carry handle, 15 pc set in tray for easy storage and connection to tool roller cabinet drawers.
- Ink-filled labels for clear visibility.
- 15° offset box for better accessibility.
- Chrome alloy steel, chrome plated.

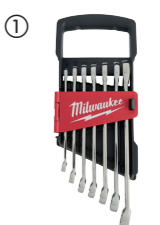

Description	Pack quantity	Min. order quantity	Article Number	EAN Code
MAX BITE™ metric combination spanner set (7 pc)				
① 8, 10, 12, 13, 14, 15, 17 mm	7	1	4932464257	4058546222024
MAX BITE™ metric combination spanner set (15 pc)				
② 8, 9, 10, 11, 12, 13, 14, 15, 16, 17, 18, 19, 20, 21, 22 mm	15	1	4932464258	4058546222031

MAX BITE™ ratcheting combination spanner

- 144 Ratcheting teeth positions giving 2.5° arc swing allowing access in tighter spaces.
- Durable double stacked pawls for longer ratchet life.
- MAX BITE™ open-end grip reduces rounding and stripping.
- Rounded I-Beam handle for comfortable handling grip.
- Ink-filled labels for better visibility.
- Chrome alloy steel, chrome plated.



Description	Total length (mm)	Pack quantity	Min. order quantity	Article Number	EAN Code
6 mm MAX BITE™ ratcheting combination spanner	134	1	1	4932480209	4058546404949
7 mm MAX BITE™ ratcheting combination spanner	142	1	1	4932480210	4058546404956
8 mm MAX BITE™ ratcheting combination spanner	146	1	1	4932471501	4058546294007
9 mm MAX BITE™ ratcheting combination spanner	156	1	1	4932471502	4058546294014
10 mm MAX BITE™ ratcheting combination spanner	165	1	1	4932471503	4058546294021
11 mm MAX BITE™ ratcheting combination spanner	172	1	1	4932471504	4058546294038
12 mm MAX BITE™ ratcheting combination spanner	179	1	1	4932471505	4058546294045
13 mm MAX BITE™ ratcheting combination spanner	187	1	1	4932471506	4058546294052
14 mm MAX BITE™ ratcheting combination spanner	198	1	1	4932471507	4058546294069
15 mm MAX BITE™ ratcheting combination spanner	208	1	1	4932471508	4058546294076
16 mm MAX BITE™ ratcheting combination spanner	218	1	1	4932471509	4058546294083
17 mm MAX BITE™ ratcheting combination spanner	234	1	1	4932471510	4058546294090
18 mm MAX BITE™ ratcheting combination spanner	243	1	1	4932471511	4058546294106
19 mm MAX BITE™ ratcheting combination spanner	258	1	1	4932471512	4058546294113
20 mm MAX BITE™ ratcheting combination spanner	272	1	1	4932471513	4058546294120
21 mm MAX BITE™ ratcheting combination spanner	282	1	1	4932471514	4058546294137
22 mm MAX BITE™ ratcheting combination spanner	303	1	1	4932471515	4058546294144
24 mm MAX BITE™ ratcheting combination spanner	320	1	1	4932480211	4058546404963
25 mm MAX BITE™ ratcheting combination spanner	341	1	1	4932480212	4058546404970
27 mm MAX BITE™ ratcheting combination spanner	367	1	1	4932480213	4058546404987
30 mm MAX BITE™ ratcheting combination spanner	393	1	1	4932480214	4058546404994
32 mm MAX BITE™ ratcheting combination spanner	429	1	1	4932480215	4058546405007

MAX BITE™ ratcheting combination spanner sets

- 144 Ratcheting teeth positions giving 2.5° arc swing allowing access in tighter spaces.
- Durable double stacked pawls for long-lasting ratchet life.
- MAX BITE™ open-end grip reduces rounding and stripping.
- Ink-filled labels for clear visibility.
- Chrome alloy steel, chrome plated.
- Rounded I-Beam handle for comfortable handling grip.



Description	Pack quantity	Min. order quantity	Article Number	EAN Code
① MAX BITE™ ratcheting metric combination spanner set (7 pc) 8, 10, 12, 13, 14, 15, 17 mm	7	1	4932464993	4058546229382
② MAX BITE™ ratcheting metric combination spanner set (15 pc) 8, 9, 10, 11, 12, 13, 14, 15, 16, 17, 18, 19, 20, 21, 22 mm	15	1	4932464994	4058546229399

MAX BITE™ flexible head ratcheting combination spanner

- 180° pivoting head for greater access to tight spaces.
- MAX BITE™ open-end grip reduces rounding and stripping.
- 144 ratcheting teeth positions giving 2.5° arc swing allowing access in tighter spaces.
- Durable double stacked pawls for longer ratchet life.
- Rounded I-Beam handle for comfortable handling grip.
- Ink-filled labels for better visibility.
- Chrome alloy steel, chrome plated.



Description	Total length (mm)	Pack quantity	Min. order quantity	Article Number	EAN Code
8 mm MAX BITE™ flexible head ratcheting combination spanner	146	1	1	4932480181	4058546404666
9 mm MAX BITE™ flexible head ratcheting combination spanner	156	1	1	4932480182	4058546404673
10 mm MAX BITE™ flexible head ratcheting combination spanner	165	1	1	4932480183	4058546404680
11 mm MAX BITE™ flexible head ratcheting combination spanner	172	1	1	4932480184	4058546404697
12 mm MAX BITE™ flexible head ratcheting combination spanner	179	1	1	4932480185	4058546404703
13 mm MAX BITE™ flexible head ratcheting combination spanner	187	1	1	4932480186	4058546404710
14 mm MAX BITE™ flexible head ratcheting combination spanner	198	1	1	4932480187	4058546404727
15 mm MAX BITE™ flexible head ratcheting combination spanner	208	1	1	4932480188	4058546404734
16 mm MAX BITE™ flexible head ratcheting combination spanner	218	1	1	4932480189	4058546404741
17 mm MAX BITE™ flexible head ratcheting combination spanner	233	1	1	4932480190	4058546404758
18 mm MAX BITE™ flexible head ratcheting combination spanner	243	1	1	4932480191	4058546404765
19 mm MAX BITE™ flexible head ratcheting combination spanner	256	1	1	4932480192	4058546404772
20 mm MAX BITE™ flexible head ratcheting combination spanner	272	1	1	4932480193	4058546404789
21 mm MAX BITE™ flexible head ratcheting combination spanner	282	1	1	4932480194	4058546404796
22 mm MAX BITE™ flexible head ratcheting combination spanner	303	1	1	4932480195	4058546404802

MAX BITE™ flexible head ratcheting combination spanner set

- 180° pivoting head for greater access to tight spaces.
- MAX BITE™ open-end grip reduces rounding and stripping.
- 144 ratcheting teeth positions giving 2.5° arc swing allowing access in tighter spaces.
- Durable double stacked pawls for longer ratchet life.
- Rounded I-Beam handle for comfortable handling grip.
- Ink-filled labels for better visibility.
- Chrome alloy steel, chrome plated.

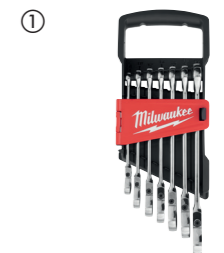

Description	Pack quantity	Min. order quantity	Article Number	EAN Code
① MAX BITE™ metric flexible head ratcheting combination spanner set (7 pc) 8, 10, 12, 13, 14, 15, 17 mm	7	1	4932478557	4058546347505
② MAX BITE™ metric flexible head ratcheting combination spanner set (15 pc) 8, 9, 10, 11, 12, 13, 14, 15, 16, 17, 18, 19, 20, 21, 22 mm	15	1	4932478558	4058546347512

Double open end spanner

- Slim head dimensions for access in tight areas.
- Rounded I-beam handle for comfortably applying torque.
- Ink-filled size labels for easy and quick size identification.
- Chrome finish for corrosion and rust resistance.



Description	Size (mm)	Pack quantity	Min. order quantity	Article Number	EAN Code
Double open end spanner - 4x5mm	4x5mm	1	1	4932492715	4058546475864
Double open end spanner - 6x7mm	6x7mm	1	1	4932492716	4058546475871
Double open end spanner - 8x9mm	8x9mm	1	1	4932492717	4058546475888
Double open end spanner - 8x10mm	8x10mm	1	1	4932492718	4058546475895
Double open end spanner - 10x11mm	10x11mm	1	1	4932492719	4058546475901
Double open end spanner - 10x13mm	10x13mm	1	1	4932492720	4058546475918
Double open end spanner - 12x13mm	12x13mm	1	1	4932492721	4058546475925
Double open end spanner - 12x14mm	12x14mm	1	1	4932492722	4058546475932
Double open end spanner - 13x17mm	13x17mm	1	1	4932492723	4058546475949
Double open end spanner - 14x15mm	14x15mm	1	1	4932492724	4058546475956
Double open end spanner - 16x17mm	16x17mm	1	1	4932492725	4058546475963
Double open end spanner - 17x19mm	17x19mm	1	1	4932492726	4058546475970
Double open end spanner - 18x19mm	18x19mm	1	1	4932492727	4058546475987
Double open end spanner - 20x22mm	20x22mm	1	1	4932492728	4058546475994
Double open end spanner - 21x23mm	21x23mm	1	1	4932492729	4058546476007
Double open end spanner - 22x24mm	22x24mm	1	1	4932492730	4058546476014
Double open end spanner - 24x26mm	24x26mm	1	1	4932493258	4058546481292
Double open end spanner - 24x27mm	24x27mm	1	1	4932492731	4058546476021
Double open end spanner - 25x28mm	25x28mm	1	1	4932492732	4058546476038
Double open end spanner - 27x29mm	27x29mm	1	1	4932492733	4058546476045
Double open end spanner - 30x32mm	30x32mm	1	1	4932492734	4058546476052
Double open end spanner - 34x36mm	34x36mm	1	1	4932492735	4058546476069
Double open end spanner - 36x41mm	36x41mm	1	1	4932492736	4058546476076

Double open end spanner sets

- Slim head dimensions for access in tight areas.
- Rounded I-beam handle for comfortably applying torque.
- Ink-filled size labels for easy and quick size identification.
- Chrome finish for corrosion and rust resistance.
- Sets come in a durable pouch.

Description	Pack quantity	Min. order quantity	Article Number	EAN Code
① Double open end spanner set - 7 pc 6x7mm, 8x9mm, 10x11mm, 12x13mm, 14x15mm, 16x17mm, 18x19mm	7	1	4932492713	4058546475840
② Double open end spanner set - 12 pc 6x7mm, 8x9mm, 10x11mm, 12x13mm, 14x15mm, 16x17mm, 18x19mm, 20x22mm, 21x23mm, 25x28mm, 27x29mm, 30x32mm	12	1	4932492714	4058546475857

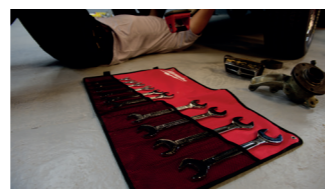
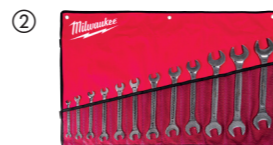

Double ring offset spanner

- 75° offset handle for better access in tight spaces.
- Rounded I-beam handle for comfortably applying torque.
- Ink-filled size labels for easy and quick size identification.
- Chrome finish for corrosion and rust resistance.



Description	Pack quantity	Min. order quantity	Article Number	EAN Code
6x7mm Double ring offset spanner	1	1	4932492739	4058546476106
8x9mm Double ring offset spanner	1	1	4932492740	4058546476113
8x10mm Double ring offset spanner	1	1	4932492741	4058546476120
10x11mm Double ring offset spanner	1	1	4932492742	4058546476137
12x13mm Double ring offset spanner	1	1	4932492743	4058546476144
14x15mm Double ring offset spanner	1	1	4932492744	4058546476151
16x17mm Double ring offset spanner	1	1	4932492745	4058546476168
17x19mm Double ring offset spanner	1	1	4932492746	4058546476175
18x19mm Double ring offset spanner	1	1	4932492747	4058546476182
19x22mm Double ring offset spanner	1	1	4932492748	4058546476199
20x22mm Double ring offset spanner	1	1	4932492749	4058546476205
21x23mm Double ring offset spanner	1	1	4932492750	4058546476212
22x24mm Double ring offset spanner	1	1	4932492751	4058546476229
24x26mm Double ring offset spanner	1	1	4932492752	4058546476236
24x27mm Double ring offset spanner	1	1	4932492753	4058546476243
25x28mm Double ring offset spanner	1	1	4932493275	4058546481469
27x30mm Double ring offset spanner	1	1	4932492754	4058546476250
27x32mm Double ring offset spanner	1	1	4932492755	4058546476267
30x32mm Double ring offset spanner	1	1	4932492756	4058546476274

Double ring offset spanner sets

- 75° offset handle for better access in tight spaces.
- Rounded I-beam handle for comfortably applying torque.
- Ink-filled size labels for easy and quick size identification.
- Chrome finish for corrosion and rust resistance.

Description	Pack quantity	Min. order quantity	Article Number	EAN Code
① 7pc Double ring offset spanner 6x7mm, 8x9mm, 10x11mm, 12x13mm, 14x15mm, 16x17mm, 18x19mm	7	1	4932492737	4058546476083
② 12pc Double ring offset spanner set 6x7mm, 8x9mm, 10x11mm, 12x13mm, 14x15mm, 16x17mm, 18x19mm, 20x22mm, 21x23mm, 24x27mm, 25x28mm, 30x32mm	12	1	4932492738	4058546476090

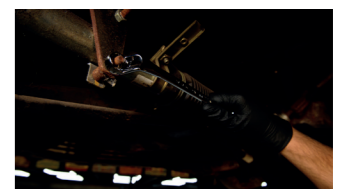

Flare nut spanners

- Optimized head geometry for secure grip on fasteners to reduce rounding of nuts.
- I-beam handle for more comfort while applying high torque.
- Ink-filled size labels for easy and quick size identification.
- 15° angled heads for better access.



Description	Pack quantity	Min. order quantity	Article Number	EAN Code
8 x 10 mm Flare nut spanner	1	1	4932480626	4058546409111
9 x 11 mm Flare nut spanner	1	1	4932480575	4058546408602
10 x 11 mm Flare nut spanner	1	1	4932480627	4058546409128
10 x 12 mm Flare nut spanner	1	1	4932480576	4058546408619
12 x 14 mm Flare nut spanner	1	1	4932480629	4058546409142
13 x 14 mm Flare nut spanner	1	1	4932480577	4058546408626
14 x 17 mm Flare nut spanner	1	1	4932480630	4058546409159
17 x 19 mm Flare nut spanner	1	1	4932480631	4058546409166
19 x 22 mm Flare nut spanner	1	1	4932480632	4058546409173

Flare nut spanner set

- Optimized head geometry for secure grip on fasteners to reduce rounding of nuts.
- I-beam handle for more comfort while applying high torque.
- Ink-filled size labels for easy and quick size identification.
- 15° angled heads for better access.
- Durable storage tray.



Description	Pack quantity	Min. order quantity	Article Number	EAN Code
6pc Flare nut spanner set	6	1	4932480636	4058546409210
8x10mm, 10x11mm, 12x14mm, 14x17mm, 17x19mm, 19x22mm				

15 pc MAXBITE combination spanner set with PACKOUT™ compact organiser

- MAX BITE™ open-end grip reduces rounding and stripping.
- Rounded I-Beam handle for comfortable handling grip.
- Optimised storage: 7 pc set with carry handle, 15 pc set in tray for easy storage and connection to tool roller cabinet drawers.
- Ink-filled labels for clear visibility.
- 15° offset box for better accessibility.
- Part of the PACKOUT™ modular storage system & constructed with impact resistant polymers for jobsite durability.



Description	Pack quantity	Min. order quantity	Article Number	EAN Code
15 pc MAXBITE combination spanner set with PACKOUT™ compact organiser	15	1	4932498141	4058546513016
PACKOUT™ compact organiser (4932464083), MAXBITE combination spanners 8, 9, 10, 11, 12, 13, 14, 15, 16, 17, 18, 19, 20, 21 & 22mm, tray inlay				

Ratchet and socket sets

- 90 tooth design with 4 °of arc swing for tight work spaces.
- Comes with a removable inner tray perfectly designed to be stored.
- Sockets are stamped with measurements on the flat side for easy-to-read visibility.
- All metal design for maximum durability.
- FOUR FLAT™ sides on socket deter rolling.
- Slim profile head with flush direction lever offers better accessibility.



Description	Pack quantity	Min. order quantity	Article Number	EAN Code
① Metric 1/4" ratchet + socket set (28 pc) Standard sockets: 5 mm, 5.5 mm, 6 mm, 7 mm, 8 mm, 9 mm, 10 mm, 11 mm, 12 mm, 13 mm, 14 mm, 15 mm / Deep well sockets: 5 mm, 5.5 mm, 6 mm, 7 mm, 8 mm, 9 mm, 10 mm, 11 mm, 12 mm, 13 mm, 14 mm, 15 mm / 76 mm extension, 152 mm extension, Universal Joint	28	1	4932464943	4058546228880
② Metric & imperial 1/4" ratchet + socket set (50 pc) Standard sockets: 5/32", 3/16", 1/8", 9/32", 1/4", 5/16", 3/8", 11/32", 3/8", 7/16", 1/2", 9/16", 5 mm, 5.5 mm, 6 mm, 7 mm, 8 mm, 9 mm, 10 mm, 11 mm, 12 mm, 13 mm, 14 mm, 15 mm / Deep well socket: 5/32", 3/16", 1/8", 9/32", 1/4", 5/16", 3/8", 11/32", 3/8", 7/16", 1/2", 9/16", 5 mm, 5.5 mm, 6 mm, 7 mm, 8 mm, 9 mm, 10 mm, 11 mm, 12 mm, 13 mm, 14 mm, 15 mm / 76 mm extension, 152 mm extension, universal joint	50	1	4932464944	4058546228897
③ Metric 3/8" ratchet + socket set (32 pc) Standard sockets: 6 mm, 7 mm, 8 mm, 9 mm, 10 mm, 11 mm, 12 mm, 13 mm, 14 mm, 15 mm, 16 mm, 17 mm, 18 mm, 19 mm / Deep well sockets: 6 mm, 7 mm, 8 mm, 9 mm, 10 mm, 11 mm, 12 mm, 13 mm, 14 mm, 15 mm, 16 mm, 17 mm, 18 mm, 19 mm / 76 mm extension, 152 mm extension, universal joint	32	1	4932464945	4058546228903
④ Metric & imperial 3/8" ratchet + socket set (56 pc) Standard sockets: 1/4", 5/16", 3/8", 7/16", 1/2", 9/16", 5/8", 11/16", 3/4", 13/16", 7/8", 15/16", 1", 6 mm, 7 mm, 8 mm, 9 mm, 10 mm, 11 mm, 12 mm, 13 mm, 14 mm, 15 mm, 16 mm, 17 mm, 18 mm, 19 mm / Deep well sockets: 1/4", 5/16", 3/8", 7/16", 1/2", 9/16", 5/8", 11/16", 3/4", 13/16", 7/8", 15/16", 1", 6 mm, 7 mm, 8 mm, 9 mm, 10 mm, 11 mm, 12 mm, 13 mm, 14 mm, 15 mm, 16 mm, 17 mm, 18 mm, 19 mm / 76 mm extension, 152 mm extension, universal joint	56	1	4932464946	4058546228910
⑤ Metric 1/2" ratchet + socket set (28 pc) Standard sockets: 10 mm, 11 mm, 12 mm, 13 mm, 14 mm, 15 mm, 16 mm, 17 mm, 18 mm, 19 mm, 20 mm, 21 mm, 22 mm, 23 mm, 24 mm / Deep well sockets: 10 mm, 11 mm, 12 mm, 13 mm, 14 mm, 15 mm, 16 mm, 17 mm, 18 mm, 19 mm / 76 mm extension, 127 mm extension & removable storage tray	28	1	4932471864	4058546297633
⑥ Metric 1/4" ratchet + socket set (28 pc) in PACKOUT™ compact slim organiser Standard sockets: 5 mm, 5.5 mm, 6 mm, 7 mm, 8 mm, 9 mm, 10 mm, 11 mm, 12 mm, 13 mm, 14 mm, 15 mm / Deep well sockets: 5 mm, 5.5 mm, 6 mm, 7 mm, 8 mm, 9 mm, 10 mm, 11 mm, 12 mm, 13 mm, 14 mm, 15 mm / 76 mm extension, 152 mm extension, Universal Joint	28	1	4932478812	4058546360948
⑦ Metric 3/8" ratchet + socket set (32 pc) in PACKOUT™ compact slim organiser Standard sockets: 6 mm, 7 mm, 8 mm, 9 mm, 10 mm, 11 mm, 12 mm, 13 mm, 14 mm, 15 mm, 16 mm, 17 mm, 18 mm, 19 mm / Deep well sockets: 6 mm, 7 mm, 8 mm, 9 mm, 10 mm, 11 mm, 12 mm, 13 mm, 14 mm, 15 mm, 16 mm, 17 mm, 18 mm, 19 mm / 76 mm extension, 152 mm extension, universal joint	32	1	4932478813	4058546360955
⑧ PACKOUT™ 1/4" & 1/2" 63pc ratchet and socket set PACKOUT SLIM ORGANISER, 1/2" Drive Standard sockets: 10 mm, 11 mm, 12 mm, 13 mm, 14 mm, 15 mm, 16 mm, 17 mm, 18 mm, 19 mm, 20 mm, 21 mm, 22 mm, 23 mm, 24 mm, 25 mm, 26 mm / Deep sockets: 10 mm, 11 mm, 12 mm, 13 mm, 14 mm, 15 mm, 16 mm, 17 mm, 18 mm, 19 mm / 1/2" Drive 76 mm extension, 127 mm extension, 1/2 Drive Universal joint; 1/4" Drive Standard sockets: 4mm, 4.5mm, 5 mm, 5.5 mm, 6 mm, 7 mm, 8 mm, 9 mm, 10 mm, 11 mm, 12 mm, 13 mm, 14 mm, 15 mm / Deep well sockets: 4 mm, 4.5 mm, 5 mm, 5.5 mm, 6 mm, 7 mm, 8 mm, 9 mm, 10 mm, 11 mm, 12 mm, 13 mm, 14 mm, 15 mm / 1/4" Drive 76 mm extension, 152 mm extension, 1/4" Drive Universal Joint	63	1	4932493661	4058546485320



1/4" Ratchet, driver & socket set

- 90 tooth design with 4 ° of arc swing for tight work spaces.
- FOUR FLAT™ sides on socket deter rolling.
- Sockets are stamped with measurements on the flat side for easy-to-read visibility.
- Comfortable Tri-Lobe screwdriver handle optimised for maximum user comfort and high torque applications.
- SHOCKWAVE™ IMPACT DUTY Screwdriver bits

Description	Pack quantity	Min. order quantity	Article Number	EAN Code
① 1/4" Ratchet, Driver & Socket set in PACKOUT™ compatible box	38	1	4932498381	4058546522506

1/4 Ratchet , 1/4 Tri-lobe screwdriver handle, Standard sockets: 5.5 mm, 6 mm, 7 mm 8 mm, 9 mm, 10 mm, 11 mm, 12 mm, 13 mm, 14 mm, Extensions: 76 mm, 152 mm, Shockwave Bits: SL4.5 / SL5.5 / SL6.5 / PH1 / PH2 / PH3 / PZ1 / PZ2 / PZ3 / HEX 3 / HEX 4 / HEX 5 / HEX 6 / HEX 8 / TR10 / TR15 / TR20 / TR25 / TR27 / TR30 / TR40, Uni joint, Socket adaptor, 1/4SQ-1/4 Hex socket



DESIGNED FOR USE IN
PACKOUT™



NEW

1/4" Compact ratchet set

- MILWAUKEE® ratchet with 90 ratcheting teeth for only 4° of arc swing and stubby handle design for better access.
- FOUR FLAT SIDES™ sockets providing a wrench ready and anti-roll design.
- Designed for use with impact drivers the SHOCKWAVE™ IMPACT DUTY bits line is not only ideal for heavy duty impact applications, but also delivers a full system solution for all the user's drilling and fastening needs.
- High quality textile pouch and removable foam insert.

Description	Pack quantity	Min. order quantity	Article Number	EAN Code
1/4" Compact Ratchet Set 39 PC	39	6	4932492672	4058546475437

1/4" compact ratchet, 1/4" universal joint, 76mm extension, 13x 1/4" sockets (4, 4.5, 5, 5.5, 6, 7, 8, 9, 10, 11, 12, 13, 14mm) , 1/4" Sq to 1/4" socket adapter, 22x SHOCKWAVE™ IMPACT DUTY Bits (PH1, PH2, PZ1, PZ2, TX B08, TX B010, TX B015, TX B020, TX B025, TX B030, TX B040, SL0.8x5x5, TX 10, TX 15, TX 20, TX 25, TX 30, TX 40, Hex 3mm, Hex 4mm, Hex 5mm, Hex 6mm)



1/4" Drive ratchet, spanner & deep socket premium set

- MILWAUKEE® ratchet with 90 ratcheting teeth for only 4° of arc swing and stubby handle design for better access.
- FOUR FLAT™ sides on socket deter rolling and wrench-ready design.
- Flex head ratcheting spanner with 144 tooth count providing an arc swing of 2.5° allowing access in tighter spaces.
- SHOCKWAVE™ IMPACT DUTY Screwdriver bits

Description	Pack quantity	Min. order quantity	Article Number	EAN Code
42 pc 1/4" Drive ratchet, spanner & deep socket premium set metric	42	1	4932498382	4058546522513

1/4" Drive deep sockets: 5, 6, 7, 8, 9, 10, 11, 12, 13, 14, 15 mm, Screwdriver handle, SHOCKWAVE™ IMPACT DUTY screwdriver bits: PH1, PH2, PH3, PZ1, PZ2, PZ3, SL 4.5, SL 5.5, Hex 3, Hex 4, Hex 5, Hex 6, Hex 8, T10 B0, T15 B0, T20 B0, T25 B0, T27 B0, T30 B0, T40 B0, Flex Head Ratcheting Combination Spanner: 8 mm, 10 mm, 13 mm



DESIGNED FOR USE IN
PACKOUT™



NEW

Tradesman 3/8" ratchet set

- Pivoting ratchet head.
- Slim profile design for better access.
- Square shaped sockets compatible with combination spanners.
- Organised and portable storage solution.

Description	Pack quantity	Min. order quantity	Article Number	EAN Code
Tradesman 3/8" ratchet set (12 pc)				

3/8" sockets: 10, 12, 13, 14, 15, 17, 18 and 19 mm. 3/8" ratchet. 152 mm extension. 1/4" to 3/8" adaptor and 3/8" to 1/4" adaptor

12 1 48229001 045242495078 6 13 6 13

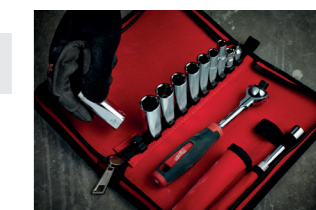

1/4" drive ratchet

- 90 tooth design with 4 ° of arc swing for tight work spaces.
- Slim profile head with flush direction lever offers better accessibility.



Description	Length (mm)	Pack quantity	Min. order quantity	Article Number	EAN Code
① 1/4" drive compact ratchet	76	1	1	4932479646	4058546374402
② 1/4" drive ratchet	152	1	1	48229014	045242513017
③ 1/4" drive long ratchet	229	1	1	4932479647	4058546374419

1/4" drive flex head ratchet

- 90 tooth design with 4 ° of arc swing for tight work spaces.
- Versatile lockable flex head: Switch between 7 locking positions and freely moving head.
- Slim profile head with flush direction lever offers better accessibility.
- Standard and extended handle lengths for easier access in tight spaces or extra leverage.



Description	Length (mm)	Pack quantity	Min. order quantity	Article Number	EAN Code
1/4" drive flexible head ratchet	140	1	1	4932479648	4058546374426
1/4" drive long flexible head ratchet	229	1	1	4932479649	4058546374433

Spinner handle

- Ergonomically shaped TRI-LOBE handle design to comfortably apply high torque.
- Anti-roll protection due to TRI-LOBE design.
- Ball detent for a secure hold onto sockets.
- Lanyard hole for easy attachment to the Milwaukee safety range to allow use at heights.



Description	Pack quantity	Min. order quantity	Article Number	EAN Code
1/4" Drive spinner handle	1	1	4932493960	4058546511203

1/4" Drive chrome sockets with FOUR FLAT™ sides

- FOUR FLAT™ sides on socket deter rolling.
- Wrench ready FOUR FLAT™ sides.
- Stamped sizes for easy visibility.
- Chrome finish.



Description	Width (mm)	Diameter (mm)	Length (mm)	Pack quantity	Min. order quantity	Article Number	EAN Code
1/4" drive - 4 mm	9.7	6.8	25	1	1	4932479992	4058546377861
1/4" drive - 4.5 mm	9.7	7.2	25	1	1	4932479993	4058546377878
1/4" drive - 5 mm	9.5	8	25	1	1	4932478312	4058546345037
1/4" drive - 5.5 mm	9.5	8.6	25	1	1	4932478313	4058546345044
1/4" drive - 6 mm	9.5	9.5	25	1	1	4932478314	4058546345051
1/4" drive - 7 mm	9.5	10.7	25	1	1	4932478315	4058546345068
1/4" drive - 8 mm	9.5	11.8	25	1	1	4932478316	4058546345075
1/4" drive - 9 mm	11.1	12.8	25	1	1	4932478317	4058546345082
1/4" drive - 10 mm	11.1	14.5	25	1	1	4932478318	4058546345099
1/4" drive - 11 mm	12.7	15.8	25	1	1	4932478319	4058546345105
1/4" drive - 12 mm	14	16.8	25	1	1	4932478320	4058546345112
1/4" drive - 13 mm	14.3	17.8	25	1	1	4932478321	4058546345129
1/4" drive - 14 mm	15.9	19.8	25	1	1	4932478322	4058546345136
1/4" drive - 15 mm	16	20.8	25	1	1	4932478323	4058546345143
1/4" deep drive - 4 mm	9.7	7.2	50	1	1	4932479994	4058546377885
1/4" deep drive - 4.5 mm	9.7	20.8	50	1	1	4932479995	4058546377892
1/4" drive deep - 5 mm	9.3	8	50	1	1	4932478324	4058546345150
1/4" drive deep - 5.5 mm	9.3	8.6	50	1	1	4932478325	4058546345167
1/4" drive deep - 6 mm	9.3	9.8	50	1	1	4932478326	4058546345174
1/4" drive deep - 7 mm	9.3	10.8	50	1	1	4932478327	4058546345181
1/4" drive deep - 8 mm	9.3	11.8	50	1	1	4932478328	4058546345198
1/4" drive deep - 9 mm	10.8	12.8	50	1	1	4932478329	4058546345204
1/4" drive deep - 10 mm	10.8	14.8	50	1	1	4932478330	4058546345211
1/4" drive deep - 11 mm	12.4	15.8	50	1	1	4932478331	4058546345228
1/4" drive deep - 12 mm	13.7	16.8	50	1	1	4932478332	4058546345235
1/4" drive deep - 13 mm	14	17.8	50	1	1	4932478333	4058546345242
1/4" drive deep - 14 mm	15.6	19.8	50	1	1	4932478334	4058546345259
1/4" drive deep - 15 mm	15.6	20.8	50	1	1	4932478335	4058546345266

1/4" Drive hex bit socket

NEW

- FOUR FLAT™ sides on socket deter rolling and provide a wrench-ready design.
- Slim design for better access in tight spaces.
- Single forged piece adds durability in high torque applications.
- Stamped sizes for better visibility in all lighting conditions.



Description	Pack quantity	Min. order quantity	Article Number	EAN Code
1/4" Drive 2mm hex bit socket	1	1	4932480823	4058546411084
1/4" Drive 2.5mm hex bit socket	1	1	4932480824	4058546411091
1/4" Drive 3mm hex bit socket	1	1	4932480825	4058546411107
1/4" Drive 4mm hex bit socket	1	1	4932480826	4058546411114
1/4" Drive 5mm hex bit socket	1	1	4932480827	4058546411121
1/4" Drive 6mm hex bit socket	1	1	4932480828	4058546411138
1/4" Drive Metric Hex Bit Socket Set - 6 pc 2mm, 2.5mm, 3mm, 4mm, 5mm, 6mm	6	1	4932480566	4058546408510



1/4" Drive torx bit socket

- FOUR FLAT™ sides on socket deter rolling and provide a wrench-ready design.
- Slim design for better access in tight spaces.
- Single forged piece adds durability in high torque applications.
- Stamped sizes for better visibility in all lighting conditions.

Description	Pack quantity	Min. order quantity	Article Number	EAN Code
1/4" Drive T8 Bit Socket	1	1	4932480792	4058546410773
1/4" Drive T10 Bit Socket	1	1	4932480793	4058546410780
1/4" Drive T15 Bit Socket	1	1	4932480794	4058546410797
1/4" Drive T20 Bit Socket	1	1	4932480795	4058546410803
1/4" Drive T25 Bit Socket	1	1	4932480796	4058546410810
1/4" Drive T27 Bit Socket	1	1	4932480797	4058546410827
1/4" Drive T30 Bit Socket	1	1	4932480798	4058546410834
1/4" Drive T40 Bit Socket	1	1	4932480799	4058546410841
① 1/4" Drive Torx Bit Socket Set - 6 pc T8, T10, T15, T20, T25, T27	6	1	4932480563	4058546414160
② 1/4" and 3/8" Drive Torx Bit Socket Set - 13 pc 1/4" Drive: T8, T10, T15, T20, T25, T27; 3/8" Drive: T30, T40, T45, T47, T50, T55, T60	13	1	4932480565	4058546408503

NEW



1/4" Drive adapter

- FOUR FLAT™ sides on socket deter rolling.
- Wrench ready FOUR FLAT™ sides.
- Drive size conversion for increasing the drive size of ratchet allowing usage on a wider variety of sockets.
- Laser engraved size ID for easy and quick size identification.
- Chrome finish for corrosion and rust protection.

Description	Pack quantity	Min. order quantity	Article Number	EAN Code
1/4" Drive 1/4" F X 3/8" M Adapter	1	1	4932480646	4058546409319



1/4" Drive universal joint adapter

- Universal Joint provides easier access in hard to reach spaces to get every job done, both in the garage and on the jobsite.
- Ball detent securely holds the socket to the adapter.
- Chrome finish for optimal resistance to corrosion and rust.

Description	Pack quantity	Min. order quantity	Article Number	EAN Code
1/4" Drive Universal Joint Adapter	1	1	4932493357	4058546482282



1/4" Drive bit holder

- Spring collar to securely hold bits.
- Chrome finish for improved rust protection.
- 1/4" Hex bit reception to work with the most common bit sizes.

Description	Pack quantity	Min. order quantity	Article Number	EAN Code
1/4" Drive Bit Holder for 1/4" Hex Bits	1	1	4932493961	4058546511210



1/4" Drive extensions

- Precision knurling located on the shaft and female drive end for better control when hand threading.
- Laser engraved size ID for quick and easy identification.
- Chrome finish for corrosion and rust protection.

Description	Pack quantity	Min. order quantity	Article Number	EAN Code
1/4" Drive 38mm extension	1	1	4932480907	4058546411923
1/4" Drive 76mm extension	1	1	4932480908	4058546411930
1/4" Drive 152mm extension	1	1	4932480909	4058546411947
1/4" Drive 356mm extension	1	1	4932480910	4058546411954
1/4" drive extension set - 4 pc 38mm, 76mm, 152mm, 356mm	4	1	4932480637	4058546409227

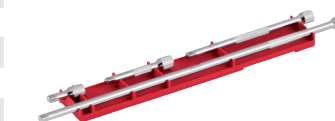

1/4" Drive wobble extensions

- Wobble functionality provides additional access in tight spaces and can also be used as a standard extension when fully inserted.
- Precision knurling located on the shaft and female drive end for better control when hand threading.
- Chrome finish for corrosion and rust protection.
- Laser engraved size ID for quick and easy identification.

Description	Pack quantity	Min. order quantity	Article Number	EAN Code
1/4" Drive 51mm wobble extension	1	1	4932480919	4058546412043
1/4" Drive 102mm wobble extension	1	1	4932480920	4058546412050
1/4" Drive 152mm wobble extension	1	1	4932480921	4058546412067
1/4" Drive 305mm wobble extension	1	1	4932480922	4058546412074
4pc 1/4" Drive wobble extension set 51mm, 102mm, 152mm, 305mm	4	1	4932480640	4058546409258



NEW

3/8" drive ratchet

- 90 tooth design with 4 ° of arc swing for tight work spaces.
- Slim profile head with flush direction lever offers better accessibility.

Description	Length (mm)	Pack quantity	Min. order quantity	Article Number	EAN Code
① 3/8" drive compact ratchet	127	1	1	4932479650	4058546374440
② 3/8" drive ratchet	216	1	1	48229038	045242513024
③ 3/8" drive long ratchet	305	1	1	4932479651	4058546374457



3/8" drive flex head ratchet

- 90 tooth design with 4 ° of arc swing for tight work spaces.
- Versatile lockable flex head: Switch between 9 locking positions and freely moving head.
- Slim profile head with flush direction lever offers better accessibility.
- Standard and extended handle lengths for easier access in tight spaces or extra leverage.



Description	Length (mm)	Pack quantity	Min. order quantity	Article Number	EAN Code
3/8" drive flexible head ratchet	216	1	1	4932479652	4058546374464
3/8" drive long flexible head ratchet	305	1	1	4932479653	4058546374471

3/8" Drive chrome sockets with FOUR FLAT™ sides

- FOUR FLAT™ sides on socket deter rolling.
- Wrench ready FOUR FLAT™ sides.
- Stamped sizes for easy visibility.
- Chrome finish.



Description	Width (mm)	Diameter (mm)	Length (mm)	Pack quantity	Min. order quantity	Article Number	EAN Code
3/8" drive - 6 mm	14.3	10.3	28	1	1	4932478336	4058546345273
3/8" drive - 7 mm	14.3	10.9	28	1	1	4932478337	4058546345280
3/8" drive - 8 mm	14.3	12	28	1	1	4932478338	4058546345297
3/8" drive - 9 mm	14.3	13.3	28	1	1	4932478339	4058546345303
3/8" drive - 10 mm	14.3	14.8	28	1	1	4932478340	4058546345310
3/8" drive - 11 mm	14.3	16.3	28	1	1	4932478341	4058546345327
3/8" drive - 12 mm	14.3	17.8	28	1	1	4932478342	4058546345334
3/8" drive - 13 mm	15.9	18.3	28	1	1	4932478343	4058546345341
3/8" drive - 14 mm	15.9	19.8	28	1	1	4932478344	4058546345358
3/8" drive - 15 mm	17	21.3	28	1	1	4932478345	4058546345365
3/8" drive - 16 mm	17.5	22	28	1	1	4932478346	4058546345372
3/8" drive - 17 mm	19	23.8	28	1	1	4932478347	4058546345389
3/8" drive - 18 mm	20	24.3	28	1	1	4932478348	4058546345396
3/8" drive - 19 mm	20	25.8	28	1	1	4932478349	4058546345402
3/8" drive - 20 mm	22.7	27.8	30	1	1	4932479996	4058546377908
3/8" drive - 21 mm	22.7	27.8	30	1	1	4932479997	4058546377915
3/8" drive - 22 mm	23.7	29.8	30	1	1	4932479998	4058546377922
3/8" drive - 23 mm	26.7	31.8	30	1	1	4932479999	4058546377939
3/8" drive - 24 mm	26.7	31.8	30	1	1	4932480000	4058546377946
3/8" drive deep - 6 mm	14	10.3	63	1	1	4932478350	4058546345419
3/8" drive deep - 7 mm	14	10.9	63	1	1	4932478351	4058546345426
3/8" drive deep - 8 mm	14	12	63	1	1	4932478352	4058546345433
3/8" drive deep - 9 mm	14	13.3	63	1	1	4932478353	4058546345440
3/8" drive deep - 10 mm	14	14.5	63	1	1	4932478354	4058546345457
3/8" drive deep - 11 mm	14	16.8	63	1	1	4932478355	4058546345464
3/8" drive deep - 12 mm	14	17.3	63	1	1	4932478356	4058546345471
3/8" drive deep - 13 mm	16	18.8	63	1	1	4932478357	4058546345488
3/8" drive deep - 14 mm	17	19.8	63	1	1	4932478358	4058546345495
3/8" drive deep - 15 mm	18	21.3	63	1	1	4932478359	4058546345501
3/8" drive deep - 16 mm	19	21.8	63	1	1	4932478360	4058546345518
3/8" drive deep - 17 mm	21	23.8	63	1	1	4932478361	4058546345525
3/8" drive deep - 18 mm	21	24.3	63	1	1	4932478362	4058546345532
3/8" drive deep - 19 mm	22	25.8	63	1	1	4932478363	4058546345549
3/8" deep drive - 20 mm	22.7	27.8	63	1	1	4932480001	4058546377953
3/8" deep drive - 21 mm	22.7	27.8	63	1	1	4932480002	4058546377960
3/8" deep drive - 22 mm	23.7	29.8	63	1	1	4932480003	4058546377977
3/8" deep drive - 23 mm	26.7	31.8	63	1	1	4932480004	4058546377984
3/8" deep drive - 24 mm	26.7	31.8	63	1	1	4932480005	4058546377991

3/8" Drive chrome socket set

- FOUR FLAT™ sides on socket deter rolling
- Wrench ready FOUR FLAT™ sides
- Stamped sizes for easy visibility
- Chrome finish for easy cleaning and corrosion protection
- Stored on a socket rail for better tool organization

Description	Height (mm)	Length (mm)	Pack quantity	Min. order quantity	Article Number	EAN Code
① 3/8" Drive 10PC Metric Chrome Sockets	44	273	10	1	4932492507	4058546418748
② 3/8" Drive 10PC Imperial Chrome Sockets	44	273	10	1	4932492508	4058546418755
③ 3/8" Drive 10 PC Metric Deep Chrome Sockets	77	273	10	1	4932492509	4058546418762
④ 3/8" Drive 10PC Imperial Deep Chrome Socket Set	77	273	10	1	4932492510	4058546418779

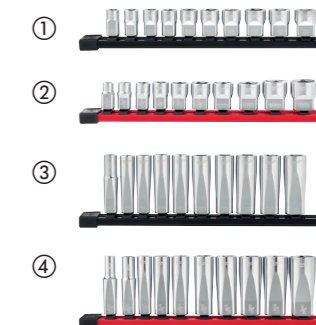

3/8" Drive spark plug socket

- Dual-material rubber retainer prevents wear down and enables secure hold.
- Stamped sizes for quick and easy identification.
- Knurling area for better finger grip.
- Pin hole to enable securing of socket.



Description	Length (mm)	Diameter (mm)	Pack quantity	Min. order quantity	Article Number	EAN Code
3/8" Drive 9/16" Spark Plug Socket	68	14.29	1	1	4932480674	4058546409593
3/8" Drive 14mm Spark Plug Socket	68	14	1	1	4932480679	4058546409647
3/8" Drive 16mm Spark Plug Socket	68	16	1	1	4932480676	4058546409616
3/8" Drive 16mm Magnetic Spark Plug Socket	68	16	1	1	4932480675	4058546409609
3/8" Drive 18mm Spark Plug Socket	68	18	1	1	4932480680	4058546409654
3/8" Drive 20.8mm Spark Plug Socket	68	20.8	1	1	4932480677	4058546409623
3/8" Drive 20.8mm Magnetic Spark Plug Socket	68	20.8	1	1	4932480678	4058546409630



3/8" Drive spark plug socket set 4pc

NEW

- Dual-material rubber retainer prevents wear down and enables secure hold.
- Stamped sizes for quick and easy identification.
- Knurling area for better finger grip.
- Pin hole to enable securing of socket.

Description	Min. order quantity	Pack quantity	Article Number	EAN Code
4pc 3/8" Drive spark plug socket set on rail	1	1	4932498383	4058546522520



3/8" Drive torx bit socket

- FOUR FLAT™ sides on socket deter rolling and provide a wrench-ready design.
- Slim design for better access in tight spaces.
- Single forged piece adds durability in high torque applications.
- Stamped sizes for better visibility in all lighting conditions.

Description	Pack quantity	Min. order quantity	Article Number	EAN Code
3/8" Drive T10 Bit Socket	1	1	4932480800	4058546410858
3/8" Drive T15 bit socket	1	1	4932480801	4058546410865
3/8" Drive T20 bit socket	1	1	4932480802	4058546410872
3/8" Drive T25 bit socket	1	1	4932480803	4058546410889
3/8" Drive T27 bit socket	1	1	4932480804	4058546410896
3/8" Drive T30 bit socket	1	1	4932480805	4058546410902
3/8" Drive T40 bit socket	1	1	4932480806	4058546410919
3/8" Drive T45 bit socket	1	1	4932480807	4058546410926
3/8" Drive T47 bit socket	1	1	4932480808	4058546410933
3/8" Drive T50 bit socket	1	1	4932480809	4058546410940
3/8" Drive T55 bit socket	1	1	4932480810	4058546410957
3/8" Drive T60 bit socket	1	1	4932480811	4058546410964
3/8" Drive Torx Bit Socket Set - 10 pc T20, T25, T27, T30, T40, T45, T47, T50, T55, T60	10	1	4932480564	4058546408497



NEW

3/8" Drive hex bit socket

- FOUR FLAT™ sides on socket deter rolling and provide a wrench-ready design.
- Slim design for better access in tight spaces.
- Single forged piece adds durability in high torque applications.
- Stamped sizes for better visibility in all lighting conditions.

Description	Pack quantity	Min. order quantity	Article Number	EAN Code
3/8" Drive 3mm hex bit socket	1	1	4932480830	4058546411152
3/8" Drive 4mm hex bit socket	1	1	4932480831	4058546411169
3/8" Drive 5mm hex bit socket	1	1	4932480832	4058546411176
3/8" Drive 6mm hex bit socket	1	1	4932480833	4058546411183
3/8" Drive 7mm hex bit socket	1	1	4932480834	4058546411190
3/8" Drive 8mm hex bit socket	1	1	4932480835	4058546411206
3/8" Drive 9mm hex bit socket	1	1	4932480836	4058546411213
3/8" Drive 10mm hex bit socket	1	1	4932480837	4058546411220
3/8" Drive 11mm hex bit socket	1	1	4932480838	4058546411237
3/8" Drive 12mm hex bit socket	1	1	4932480839	4058546411244
3/8" Drive 13mm hex bit socket	1	1	4932480840	4058546411251
3/8" Drive 14mm hex bit socket	1	1	4932480841	4058546411268
3/8" Drive Metric Hex Bit Socket Set - 11 pc 4mm, 5mm, 6mm, 7mm, 8mm, 9mm, 10mm, 11mm, 12mm, 13mm, 14mm	11	1	4932480567	4058546408527



NEW

3/8" Drive adapter

- FOUR FLAT™ sides on socket deter rolling.
- Wrench ready FOUR FLAT™ sides.
- Drive size conversion for increasing or decreasing the drive size of ratchet allowing usage on a wider variety of sockets.
- Laser engraved size ID for easy and quick size identification.
- Chrome finish for corrosion and rust protection.

Description	Pack quantity	Min. order quantity	Article Number	EAN Code
3/8" Drive 3/4" X 1/2" M Adapter	1	1	4932480647	4058546409326
3/8" Drive 3/4" X 1/4" M Adapter	1	1	4932480648	4058546409333



3/8" Drive universal joint adapter

- Universal Joint provides easier access in hard to reach spaces to get every job done, both in the garage and on the jobsite.
- Ball detent securely holds the socket to the adapter.
- Chrome finish for optimal resistance to corrosion and rust.

Description	Pack quantity	Min. order quantity	Article Number	EAN Code
3/8" Drive Universal Joint Adapter	1	1	4932493358	4058546482299



3/8" Drive bit holder

- Ball detent for a secure hold onto bits.
- Chrome finish for improved rust protection.
- 1/4" Hex bit reception to work with the most common bit sizes.

Description	Pack quantity	Min. order quantity	Article Number	EAN Code
3/8" Drive Bit Holder for 1/4" Hex Bits	1	1	4932493962	4058546511227



3/8" Drive extensions

- Precision knurling located on the shaft and female drive end for better control when hand threading.
- Laser engraved size ID for quick and easy identification.
- Chrome finish for corrosion and rust protection.

Description	Pack quantity	Min. order quantity	Article Number	EAN Code
3/8" Drive 38mm extension	1	1	4932480911	4058546411961
3/8" Drive 76mm extension	1	1	4932480912	4058546411978
3/8" Drive 152mm extension	1	1	4932480913	4058546411985
3/8" Drive 356mm extension	1	1	4932480914	4058546411992
3/8" drive extension set - 4 pc 38mm, 76mm, 152mm, 356mm	4	1	4932480638	4058546409234



3/8" Drive wobble extensions

- Wobble functionality provides additional access in tight spaces and can also be used as a standard extension when fully inserted.
- Precision knurling located on the shaft and female drive end for better control when hand threading.
- Chrome finish for corrosion and rust protection.
- Laser engraved size ID for quick and easy identification.

Description	Pack quantity	Min. order quantity	Article Number	EAN Code
3/8" Drive 76mm wobble extension	1	1	4932480923	4058546412081
3/8" Drive 152mm wobble extension	1	1	4932480924	4058546412098
3/8" Drive 254mm wobble extension	1	1	4932480925	4058546412104
3/8" Drive 305mm wobble extension	1	1	4932480926	4058546412111
4pc 3/8" Drive wobble extension set 76mm, 152mm, 254mm, 305mm	4	1	4932480641	4058546409265

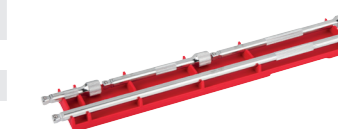

NEW

1/2" drive ratchet

- 90 tooth design with 4 ° of arc swing for tight work spaces.
- Slim profile head with flush direction lever offers better accessibility.

Description	Length (mm)	Pack quantity	Min. order quantity	Article Number	EAN Code
1/2" drive ratchet	286	1	1	4932471865	4058546297640
1/2" drive long ratchet	457	1	1	4932479654	4058546374488



1/2" drive flex head ratchet

- 90 tooth design with 4 ° of arc swing for tight work spaces.
- Versatile lockable flex head: Switch between 11 locking positions and freely moving head.
- Slim profile head with flush direction lever offers better accessibility.
- Standard and extended handle lengths for easier access in tight spaces or extra leverage.

Description	Length (mm)	Pack quantity	Min. order quantity	Article Number	EAN Code
1/2" drive flexible head ratchet	286	1	1	4932479655	4058546374495
1/2" drive long flexible head ratchet	457	1	1	4932479656	4058546374501



1/2" Drive adapter

- FOUR FLAT™ sides on socket deter rolling
- Wrench ready FOUR FLAT™ sides
- Drive size conversion for increasing the drive size of ratchet allowing usage on a wider variety of sockets
- Laser engraved size ID for easy and quick size identification
- Chrome finish for corrosion and rust protection

Description	Pack quantity	Min. order quantity	Article Number	EAN Code
1/2" Drive 1/2" F X 3/8" M Adapter	1	1	4932480649	4058546409340



1/2" Drive chrome sockets with FOUR FLAT™ sides

- FOUR FLAT™ sides on socket deter rolling.
- Wrench ready FOUR FLAT™ sides.
- Stamped sizes for easy visibility.
- Chrome finish.



Description	Width (mm)	Diameter (mm)	Length (mm)	Pack quantity	Min. order quantity	Article Number	EAN Code
1/2" drive - 8 mm	17.7	13.7	38	1	1	4932480006	4058546378004
1/2" drive - 9 mm	17.7	14.2	38	1	1	4932480007	4058546378011
1/2" drive - 10 mm	18.8	15.3	38	1	1	4932480008	4058546378028
1/2" drive - 11 mm	18.8	16.8	38	1	1	4932480009	4058546378035
1/2" drive - 12 mm	18.8	17.8	38	1	1	4932480010	4058546378042
1/2" drive - 13 mm	18.8	19	38	1	1	4932480011	4058546378059
1/2" drive - 14 mm	18.8	20.3	38	1	1	4932480012	4058546378066
1/2" drive - 15 mm	18.8	21.8	38	1	1	4932480013	4058546378073
1/2" drive - 16 mm	18.8	21.8	38	1	1	4932480014	4058546378080
1/2" drive - 17 mm	19.4	23.8	38	1	1	4932480015	4058546378097
1/2" drive - 18 mm	20.5	25.8	38	1	1	4932480016	4058546378103
1/2" drive - 19 mm	20.5	25.8	38	1	1	4932480017	4058546378110
1/2" drive - 20 mm	22.1	27.8	38	1	1	4932480018	4058546378127
1/2" drive - 21 mm	22.1	27.8	38	1	1	4932480019	4058546378134
1/2" drive - 22 mm	23.3	29.8	38	1	1	4932480020	4058546378141
1/2" drive - 23 mm	25.3	31.8	39	1	1	4932480021	4058546378158
1/2" drive - 24 mm	25.3	31.8	39	1	1	4932480022	4058546378165
1/2" drive - 25 mm	27.7	33.8	42	1	1	4932480023	4058546378172
1/2" drive - 26 mm	27.7	33.8	42	1	1	4932480024	4058546378189
1/2" drive - 27 mm	29.7	35.8	42	1	1	4932480025	4058546378196
1/2" drive - 28 mm	29.7	37.8	42	1	1	4932480026	4058546378202
1/2" drive - 30 mm	32.7	39.8	44	1	1	4932480027	4058546378219
1/2" drive - 32 mm	33.8	41.8	44	1	1	4932480028	4058546378226
1/2" drive - 36 mm	37.8	45.8	48	1	1	4932480029	4058546378233
1/2" drive deep - 10 mm	18.8	15	78	1	1	4932480030	4058546378240
1/2" drive deep - 11 mm	18.8	16.8	78	1	1	4932480031	4058546378257
1/2" drive deep - 12 mm	18.8	17.8	78	1	1	4932480032	4058546378264
1/2" drive deep - 13 mm	18.8	19	78	1	1	4932480033	4058546420550
1/2" drive deep - 14 mm	18.8	20.3	78	1	1	4932480034	4058546376048
1/2" drive deep - 15 mm	18.8	21.8	78	1	1	4932480035	4058546376055
1/2" drive deep - 16 mm	18.8	21.8	78	1	1	4932480036	4058546376062
1/2" drive deep - 17 mm	19.4	23.8	78	1	1	4932480037	4058546376079
1/2" drive deep - 18 mm	20.5	25.8	78	1	1	4932480038	4058546376086
1/2" drive deep - 19 mm	20.5	25.8	78	1	1	4932480039	4058546376093
1/2" drive deep - 20 mm	22.7	27.8	78	1	1	4932480040	4058546376109
1/2" drive deep - 21 mm	22.7	27.8	78	1	1	4932480041	4058546376116
1/2" drive deep - 22 mm	23.7	29.8	78	1	1	4932480042	4058546403270
1/2" drive deep - 23 mm	26.7	31.8	78	1	1	4932480043	4058546403287
1/2" drive deep - 24 mm	26.7	31.8	78	1	1	4932480044	4058546403294
1/2" drive deep - 27 mm	29.7	35.8	78	1	1	4932480045	4058546403300
1/2" drive deep - 30 mm	32.7	39.8	78	1	1	4932480046	4058546403317
1/2" drive deep - 32 mm	33.8	41.8	78	1	1	4932480047	4058546403324
1/2" drive deep - 36 mm	37.8	45.8	78	1	1	4932480048	4058546403331

1/2" Drive hex bit socket

NEW

- FOUR FLAT™ sides on socket deter rolling and provide a wrench-ready design.
- Slim design for better access in tight spaces.
- Single forged piece adds durability in high torque applications.
- Stamped sizes for better visibility in all lighting conditions.



Description	Min. order quantity	Pack quantity	Article Number	EAN Code
1/2" Drive 4mm hex bit socket	1	1	4932480842	4058546411275
1/2" Drive 5mm hex bit socket	1	1	4932480843	4058546411282
1/2" Drive 6mm hex bit socket	1	1	4932480844	4058546411299
1/2" Drive 7mm hex bit socket	1	1	4932480845	4058546411305
1/2" Drive 8mm hex bit socket	1	1	4932480846	4058546411312
1/2" Drive 9mm hex bit socket	1	1	4932480847	4058546411329
1/2" Drive 10mm hex bit socket	1	1	4932480848	4058546411336
1/2" Drive 12mm hex bit socket	1	1	4932480849	4058546411343
1/2" Drive 14mm hex bit socket	1	1	4932480850	4058546411350
1/2" Drive 17mm hex bit socket	1	1	4932480851	4058546411367
1/2" Drive 19mm hex bit socket	1	1	4932480852	4058546411374
1/2" Drive Metric Hex Bit Socket Set - 10 pc	1	10	4932480853	4058546411381

1/2" Drive torx bit socket

NEW

- FOUR FLAT™ sides on socket deter rolling and provide a wrench-ready design.
- Slim design for better access in tight spaces.
- Single forged piece adds durability in high torque applications.
- Stamped sizes for better visibility in all lighting conditions.



Description	Min. order quantity	Pack quantity	Article Number	EAN Code
1/2" Drive T20 Bit Socket	1	1	4932480812	4058546410971
1/2" Drive T25 Bit Socket	1	1	4932480813	4058546410988
1/2" Drive T27 Bit Socket	1	1	4932480814	4058546410995
1/2" Drive T30 Bit Socket	1	1	4932480815	4058546411008
1/2" Drive T40 Bit Socket	1	1	4932480816	4058546411015
1/2" Drive T45 Bit Socket	1	1	4932480817	4058546411022
1/2" Drive T50 Bit Socket	1	1	4932480818	4058546411039
1/2" Drive T55 Bit Socket	1	1	4932480819	4058546411046
1/2" Drive T60 Bit Socket	1	1	4932480820	4058546411053
1/2" Drive T70 Bit Socket	1	1	4932480821	4058546411060
1/2" Drive Torx Bit Socket Set - 10 pc	1	9	4932480822	4058546411077

1/2" drive universal joint

- Improved joint durability to withstand higher torque.
- Wobble drive to provide additional access and can also be used in the standard position when socket is fully inserted.
- Allows access to difficult angles that cannot be reached with a fixed ratchet and socket.
- Chrome finish for corrosion and rust resistance.
- Laser engraved size label for quick and easy identification.



Description	Pack quantity	Min. order quantity	Article Number	EAN Code
1/2" drive universal joint	1	1	4932480650	4058546409357

1/2" Drive extensions

- Precision knurling located on the shaft and female drive end for better control when hand threading.
- Laser engraved size ID for quick and easy identification.
- Chrome finish for corrosion and rust protection.



Description	Pack quantity	Min. order quantity	Article Number	EAN Code
1/2" Drive 76mm extension	1	1	4932480915	4058546412005
1/2" Drive 127mm extension	1	1	4932480916	4058546412012
1/2" Drive 254mm extension	1	1	4932480917	4058546412029
1/2" Drive 381mm extension	1	1	4932480918	4058546412036
1/2" drive extension set - 4 pc 76mm, 127mm, 254mm, 381mm	4	1	4932480639	4058546409241



1/2" Drive wobble extensions

NEW

- Wobble functionality provides additional access in tight spaces and can also be used as a standard extension when fully inserted.
- Precision knurling located on the shaft and female drive end for better control when hand threading.
- Chrome finish for corrosion and rust protection.
- Laser engraved size ID for quick and easy identification.



Description	Pack quantity	Min. order quantity	Article Number	EAN Code
1/2" Drive 76mm wobble extension	1	1	4932480927	4058546412128
1/2" Drive 127mm wobble extension	1	1	4932480928	4058546412135
1/2" Drive 254mm wobble extension	1	1	4932480929	4058546412142
3pc 1/2" Drive wobble extension set 76mm, 127mm, 254mm	3	1	4932480642	4058546409272



1/2" drive breaker bar

- Provides Extra leverage for tougher bolts.
- 180° swiveling head.



Description	Total length (mm)	Total length (inch)	Article Number	EAN Code
1/2" drive breaker drive (15)	380	15	4932471866	4058546297657
1/2" drive breaker drive (24)	610	24	4932471867	4058546297664

T-bar handle with swivel socket hex metric

NEW

- 180° Durable swiveling socket for best access hard-to-reach angles.
- Sliding handle bar to optimal adjust to different positions for more leverage or narrow spaces.
- Shallow sockets to allow fastening of nuts with longer bolts.



Description	Pack quantity	Min. order quantity	Article Number	EAN Code
T-bar handle with swivel socket hex 6mm	1	1	4932492675	4058546475468
T-bar handle with swivel socket hex 7mm	1	1	4932492676	4058546475475
T-bar handle with swivel socket hex 8mm	1	1	4932492677	4058546475482
T-bar handle with swivel socket hex 9mm	1	1	4932492678	4058546475499
T-bar handle with swivel socket hex 10mm	1	1	4932492679	4058546475505
T-bar handle with swivel socket hex 11mm	1	1	4932492680	4058546475512
T-bar handle with swivel socket hex 12mm	1	1	4932492681	4058546475529
T-bar handle with swivel socket hex 13mm	1	1	4932492682	4058546475536
T-bar handle with swivel socket hex 14mm	1	1	4932492683	4058546475543
T-bar handle with swivel socket hex 15mm	1	1	4932492684	4058546475550
T-bar handle with swivel socket hex 16mm	1	1	4932492685	4058546475567
T-bar handle with swivel socket hex 17mm	1	1	4932492686	4058546475574
T-bar handle with swivel socket hex 18mm	1	1	4932492687	4058546475581
T-bar handle with swivel socket hex 19mm	1	1	4932492688	4058546475598
T-bar handle with swivel socket hex 20mm	1	1	4932492689	4058546475604
T-bar handle with swivel socket hex 21mm	1	1	4932492690	4058546475611
T-bar handle with swivel socket hex 22mm	1	1	4932492691	4058546475628
T-bar handle with swivel socket hex 24mm	1	1	4932492692	4058546475635
7 pc T-bar handle with swivel socket set 8, 10, 11, 13, 14, 17, 19mm	7	1	4932492674	4058546475451

Pry bar

- I-Beam design for added durability.
- All-metal core for improved durability.
- Hammer-ready strike cap improves leverage when working in tight spaces.
- Comfortable Tri-Lobe handles for better grip.
- All-chrome shafts for increased durability.
- Curved claw design reduces damage when pulling nails.

Description	Pack quantity	Min. order quantity	Article Number	EAN Code
① 200mm Pry bar	1	1	4932480595	4058546408800
② 300mm Pry bar	1	1	4932480596	4058546408817
③ 450mm Pry bar	1	1	4932480597	4058546408824
④ 600mm Pry bar	1	1	4932480598	4058546408831
⑤ 900mm Pry bar	1	1	4932480599	4058546408848
⑥ 1000mm Pry bar	1	1	4932480600	4058546408855
⑦ Pry bar set - 4 pcs 200 mm - 300 mm - 450 mm - 600 mm	1	1	48229214	045242508099

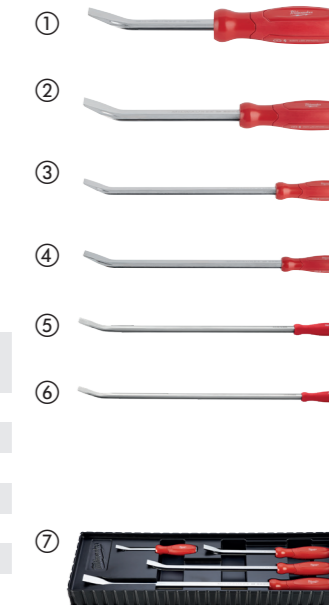

Hook & pick sets

- All-metal core for long-lasting durability and rust protection.
- Chrome-plated shanks reduce corrosion and provide rust protection.
- Comfort grip handle and precision knurling increase tool control and user comfort.
- Supplied in an easy-access storage tray for long-term tool storage.

Description	Pack quantity	Min. order quantity	Article Number	EAN Code
① Hose Pick - Flat Tip	1	1	4932480570	4058546408558
② Hose Pick - Hook	1	1	4932480571	4058546408565
③ Hose Pick - Bent 90 Degree	1	1	4932480572	4058546408572
④ Hose Pick - Bent 45 Degree	1	1	4932480573	4058546408589
⑤ Hook & pick set offset pick, straight pick, hook, 90° pick	4	1	48229215	045242508105
⑥ Heavy Duty Hook & Pick Set (4 pc) HD Flat hose pick, HD 90° hose pick, HD 45° hose pick, HD Hook hose pick, Storage tray	4	1	4932480568	4058546408534
⑦ Hook & Pick Set (8 pc) HD Flat hose pick, HD 90° hose pick, HD 45° hose pick, HD Hook hose pick, Straight pick, Offset hook, Hook, 90° hook, Storage tray	8	1	4932480569	4058546408541





Nothing but **HEAVY DUTY.**TM

Techtronic Industries UK Ltd.

Suite A, Second Floor

Marlow International

Parkway

Marlow

Bucks SL7 1YL

Tel: +44 (0) 1628 894400

Fax: +44 (0) 1628 894401

Distributed by: