

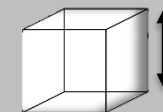

Nothing but **HEAVY DUTY.**

PACKOUT™

Dimensões

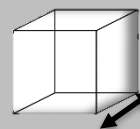
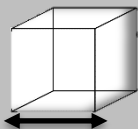

REFERÊNCIA	DESCRIÇÃO	cm	cm	cm
4932478161	CAIXA COM RODAS XL	96,5	60,9	40,1
4932464078	CAIXA COM RODAS	56,1	47,2	65
4932472131	CARRO	50,8	66	121,9
4932471068	BASE COM RODAS	62	48	19,3
4932478162	CAIXA DE FERRAMENTAS XL	55,4	39,4	42,2
4932464079	MALA GRANDE	56,1	39,4	28,2
4932464080	MALA	56,1	41,1	16,5
4932471723	CAIXA DE FERRAMENTAS COMPACTA	24,9	41,1	33
4932471724	CAIXA MULTIUSOS	47,5	38,9	25,1
4932472130	CAIXA DE 3 GAVETAS	56,4	41,4	36,3
4932472129	CAIXA DE 2 GAVETAS	56,4	41,4	36,3
4932478625	ORGANIZADOR ALTA CAPACIDADE	50	38,6	17,8
4932464082	ORGANIZADOR	50	38,6	11,7
4932464083	ORGANIZADOR COMPACTO	24,9	38,6	11,7
4932471064	ORGANIZADOR SLIM	50	41,4	6,4
4932471065	ORGANIZADOR COMPACTO SLIM	24,9	41,1	6,4
4932464084	BOLSA PORTA FERRAMENTAS DE 25cm	25,4	30,5	31,8
4932464085	BOLSA PORTA FERRAMENTAS DE 40cm	38,1	25,4	42,7
4932464086	BOLSA PORTA FERRAMENTAS DE 50cm	50,8	27,9	42,7
4932471066	BOLSA DE NYLON 38cm	40,6	25,4	30,5
4932471067	BOLSA DE NYLON DE 50cm	50,8	31,2	34,3
4932471131	MOCHILA	38,1	29,2	50,8
4932471130	BOLSA TECH	43,2	27,9	43,2
4932471722	GELEIRA RÍGIDA COMPACTA	24,9	41,1	33
4932471132	GELEIRA	39,4	25,4	40,6
4932471638	BASE DE MONTAGEM	59,4	2,8	46,7
4932472127/4932478996	RACK DE MONTAGEM/RACK DE MONTAGEM VERTICAL E-TRACK	54,6	44,7	50,8
4932478711	BANDEJA PARA RACK DE MONTAGEM	53,3	42,2	3,9
4932472128	BASE DE TRABALHO	60,7	38,9	5,3

CAIXA COM RODAS XL I REF. 4932478161



PODE EMPILHAR
2 CONJUNTOS
PACKOUT™



113kg DE
CAPACIDADE



RODAS
TODO-O-
TERRENO
DE 23cm
DE DIÂMETRO



CAIXA COM RODAS | REF. 4932464078



**RESISTENTE A
IMPACTOS**



**113kg DE
CAPACIDADE**



**RODAS
TODO-O-TERRENO
DE 23cm
DE DIÂMETRO**



**CLASSIFICAÇÃO
IP65 CONTRA
ÁGUA E POEIRAS**



CARRO I REF. 4932472131



**PARA EMPILHAR
E PENDURAR**



**180kg DE
CAPACIDADE**



**RODAS DE
25cm**



BASE COM RODAS I REF. 4932471068



**113kg DE
CAPACIDADE**



**TRAVÃO
CENTRAL**



**RODAS DE ALTA
RESISTÊNCIA**



CAIXA DE FERRAMENTAS XL I REF. 4932478162



**45kg DE
CAPACIDADE**



**RESISTENTE A
IMPACTOS**



**CLASSIFICAÇÃO
IP65 CONTRA
ÁGUA E POEIRAS**





PACKOUT™

DIMENSÕES

MALA GRANDE I REF. 4932464079



**45kg DE
CAPACIDADE**



**RESISTENTE A
IMPACTOS**



**PEGA SUPERIOR
REFORÇADA COM
METAL**



**CLASSIFICAÇÃO
IP65 CONTRA
ÁGUA E POEIRAS**

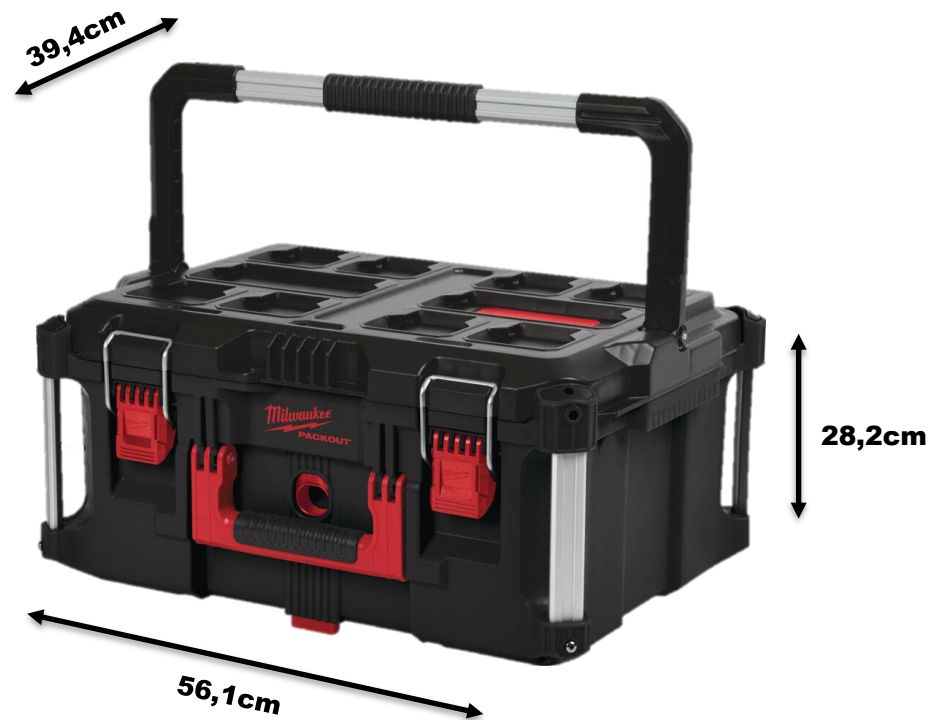

MALA GRANDE I REF. 4932464080



**34kg DE
CAPACIDADE**



**RESISTENTE A
IMPACTOS**



**CLASSIFICAÇÃO
IP65 CONTRA
ÁGUA E POEIRAS**



CAIXA DE FERRAMENTAS COMPACTA I REF. 4932471723



**34kg DE
CAPACIDADE**



**DIVISÓRIAS DE
AJUSTE RÁPIDO**



**RESISTENTE A
IMPACTOS**



**CLASSIFICAÇÃO
IP65 CONTRA
ÁGUA E POEIRAS**



CAIXA MULTIUSOS I REF. 4932471724



**PARA EMPILHAR
E PENDURAR**



**RESISTENTE A
IMPACTOS**



**22kg DE
CAPACIDADE**



CAIXA DE 3 GAVETAS I REF. 4932472130



**22kg DE
CAPACIDADE**



**BARRA DE
SEGURANÇA**



**RESISTENTE A
IMPACTOS**



CAIXA DE 2 GAVETAS | REF. 4932472129



**22kg DE
CAPACIDADE**



**BARRA DE
SEGURANÇA**



**RESISTENTE A
IMPACTOS**



ORGANIZADOR ALTA CAPACIDADE I REF. 4932478625



**22kg DE
CAPACIDADE**



**CLASSIFICAÇÃO
IP65 CONTRA
ÁGUA E POEIRAS**



**DIVISÓRIAS DE
AJUSTE RÁPIDO**



ORGANIZADOR I REF. 4932464082



**RESISTENTE A
IMPACTOS**



**CLASSIFICAÇÃO
IP65 CONTRA
ÁGUA E POEIRAS**



**SISTEMA ANTI-
MOVIMENTO**

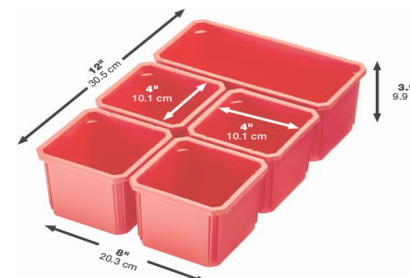

ORGANIZADOR COMPACTO I REF. 4932464083



**RESISTENTE A
IMPACTOS**



**CLASSIFICAÇÃO
IP65 CONTRA
ÁGUA E POEIRAS**



**SISTEMA ANTI-
MOVIMENTO**

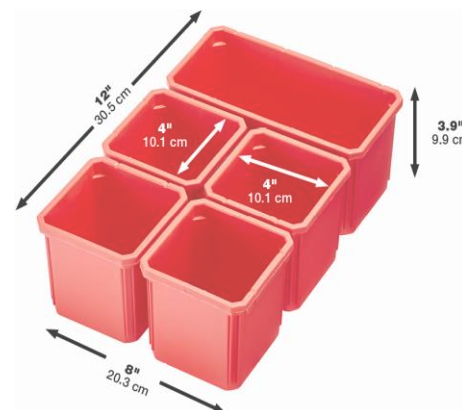

ORGANIZADOR SLIM I REF. 4932471064



**RESISTENTE A
IMPACTOS**



**CLASSIFICAÇÃO
IP65 CONTRA
ÁGUA E POEIRAS**



**SISTEMA ANTI-
MOVIMENTO**

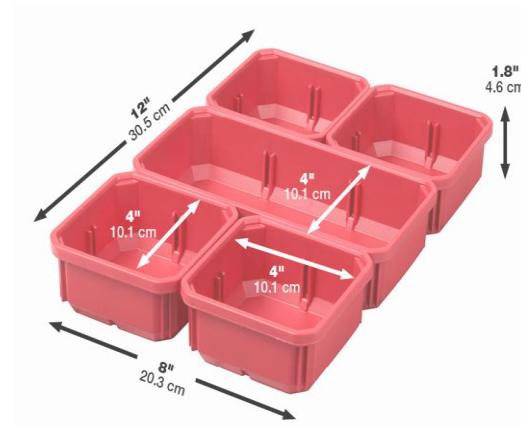

ORGANIZADOR COMPACTO SLIM I REF. 4932471065



**RESISTENTE A
IMPACTOS**



**CLASSIFICAÇÃO
IP65 CONTRA
ÁGUA E POEIRAS**



**SISTEMA ANTI-
MOVIMENTO**

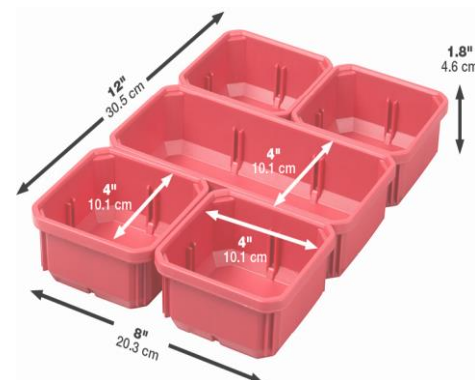

BOLSA PORTA FERRAMENTAS DE 25CM I REF. 4932464084



**MATERIAL
RESISTENTE A
RASGOS**



**CAPACIDADE DE
ARMAZENAMENTO
OTIMIZADA**



**CONSTRUÇÃO
ROBUSTA**



BOLSA PORTA FERRAMENTAS DE 40CM I REF. 4932464085



**MATERIAL
RESISTENTE A
RAGOS**



**CAPACIDADE DE
ARMAZENAMENTO
OTIMIZADA**



**CONSTRUÇÃO
ROBUSTA**





PACKOUT™

DIMENSÕES

BOLSA PORTA FERRAMENTAS DE 50CM I REF. 4932464086



**MATERIAL
RESISTENTE A
RASGOS**



**CAPACIDADE DE
ARMAZENAMENTO
OTIMIZADA**



**CONSTRUÇÃO
ROBUSTA**





PACKOUT™

DIMENSÕES

BOLSA DE NYLON DE 38CM I REF. 4932471066



**MATERIAL
RESISTENTE A
RASGOS**



**BASE
RESISTENTE A
IMPACTOS**



**CONSTRUÇÃO
ROBUSTA**



BOLSA DE NYLON DE 50CM I REF. 4932471067



**MATERIAL
RESISTENTE A
RASGOS**



**BASE
RESISTENTE A
IMPACTOS**



**CONSTRUÇÃO
ROBUSTA**



MOCHILA I REF. 4932471131



**MATERIAL
RESISTENTE A
RASGOS**



**BASE
RESISTENTE A
IMPACTOS**



**CONSTRUÇÃO
ROBUSTA**



BOLSA TECH I REF. 4932471130



**MATERIAL
RESISTENTE A
RASGOS**



**BASE
RESISTENTE A
IMPACTOS**



**CONSTRUÇÃO
ROBUSTA**



GELEIRA RÍGIDA COMPACTA I REF. 4932471722



**MANTÉM O GELO
ATÉ 30hrs**



**RESISTENTE A
IMPACTOS**



**CLASSIFICAÇÃO
IP65 CONTRA
ÁGUA E POEIRAS**





PACKOUT™

DIMENSÕES

GELEIRA I REF. 4932471132



**MANTÉM O
GELO ATÉ 24hrs**



**RESISTENTE A
IMPACTOS**



**CONSTRUÇÃO
ROBUSTA**



BASE DE MONTAGEM I REF. 4932471638



**PARA EMPILHAR
E PENDURAR**



**SUPORTA ATÉ
22kg FIXADO
NA PAREDE**



**BASE
REFORÇADA
COM METAL**



RACK DE MONTAGEM I REF. 4932472127



**MONTAGEM VERSÁTIL
COMPATÍVEL COM
E-TRACK**



**CADA ESTANTE
SUPPORTA ATÉ
22kg FIXADO NA
PAREDE**



**BASE
REFORÇADA
COM METAL**



RACK DE MONTAGEM VERTICAL E-TRACK DE 50CM I

REF. 4932478996

BANDEJA PARA RACK DE MONTAGEM I REF. 4932478711



**MONTAGEM VERSÁTIL
COMPATÍVEL COM
GUIAS E-TRACK**



**SUPORTA ATÉ
22kg FIXADO NA
PAREDE**



**BASE
REFORÇADA
COM METAL**



BASE SUPERIOR DE TRABALHO I REF. 4932472128



**SUPERFÍCIE
PREPARADA
PARA FIXAR
MATERIAIS**



**SUPORTA ATÉ
22kg FIXADO NA
PAREDE**



**RESISTENTE A
IMPACTOS**





Nothing but **HEAVY DUTY.**®
